



ZEISS Cinema Zoom Lenses

Mount Change Instructions



Table of Contents

Introduction	3
<hr/>	
Explanation of Symbols	3
Overview	4
Delivery Contents of a ZEISS CZ.2	4
Technical Data	5
Changing the Mount of a ZEISS CZ.2	6
<hr/>	
Detaching a Mount	6
Attaching a Mount	10
Adjusting a ZEISS CZ.2 to Your Digital Camera	15
<hr/>	
Testing the Sharpness	16
Correcting the Flange Focal Distance	19
Appendix	21
<hr/>	
Color Code of the Shims	21
Shimming Table	21
Mount Change Accessories	23
Glossary	23

Introduction

In this manual you learn how to change the mount of a ZEISS Cinema Zoom CZ.2 (abbreviation: ZEISS CZ.2) and how to match it to a digital camera. In order to explain the procedure, this manual uses a ZEISS CZ.2 28–80 which is scaled in feet with PL mount. Proceed in the same sequences to switch from or to any other mount that is available for the ZEISS CZ.2 (Canon¹ EF, Nikon² F, Sony³ E and MFT).

Explanation of Symbols



The information symbol indicates additional information, which is useful for the context.



The skip symbol indicates that under certain circumstances you can skip certain steps.



The result symbol indicates information about the obtained result of a step.



The warning symbol indicates dangerous situations and actions, which might impair the functionality of the product, damage the product or hurt the user.

¹ Canon is a trademark or registered trademark of Canon Inc. and/or other members of the Canon Group.

² Nikon is a registered trademark of Nikon Corporation

³ Sony and E-mount are registered trademarks of Sony Corporation

Overview

- | | | | |
|----------|---------------------|-----------|--------------------------------------|
| 1 | front lens | 9 | lens barrel |
| 2 | focus ring | 10 | groove of the lens |
| 3 | focus index mark | 11 | small screw |
| 4 | lens foot | 12 | rear lens |
| 5 | zoom index mark | 13 | shims |
| 6 | zoom ring | 14 | mount including the black inner ring |
| 7 | aperture index mark | 15 | T6 screws |
| 8 | aperture ring | | |

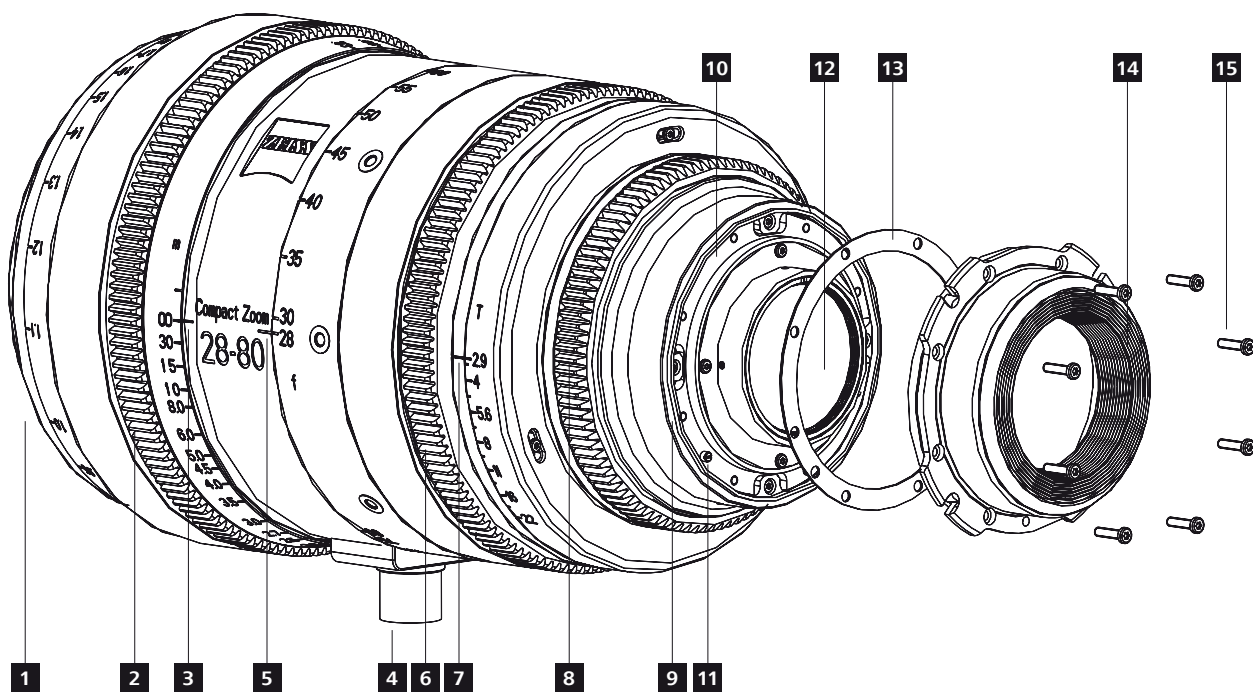

Delivery Contents of a ZEISS CZ.2

- 1x ZEISS CZ.2
- 1x Front cap
- 1x Rear cap
- 1x Focus lever
- 3x Lens support riser 3/8"

Technical Data

	Cinema Zoom 15–30 mm	Cinema Zoom 28–80 mm	Cinema Zoom 70–200 mm
Aperture range	T 2.9 to T 22	T 2.9 to T 22	T 2.9 to T 22
Focal length	15–30 mm	28–80 mm	70–200 mm
Close focus distance¹	0.55 m / 1'10"	0.83 m / 2'8"	1.51 m / 5'
Length²	198 mm / 9.92"	196 mm / 7.72"	250 mm / 9.84"
Front diameter	114 mm / 4.49"	95 mm / 3.7"	95 mm / 3.7"
Weight	2.6 kg / 5.7 lbs	2.5 kg / 5.5 lbs	2.8 kg / 6.2 lbs

Horizontal Angle of View

Full-Frame ³	100–62°	66–25°	29–10°
APS-H ⁴	90–54°	57–21°	24–9°
Super 35 ⁵	79–46°	48–18°	20–7°
Normal 35 ⁶	72–41°	43–16°	18–6°
APS-C ⁷	73–42°	43–16°	18–6°
MFT ⁸	59–33°	34–12°	14–5°

¹ Close focus distance is measured from the image plane

² Front to PL mount flange

³ Horizontal angle of view for a full-frame camera
(aspect ratio 1:1.5, dimensions 36 mm x 24 mm / 1.42" x 0.94")

⁴ Horizontal angle of view for an APS-H camera
(aspect ratio 1:1.81, dimensions 30.2 mm x 16.7 mm / 1.19" x 0.66")

⁵ Horizontal angle of view for an ANSI Super 35 Silent camera
(aspect ratio 1:1.33, dimensions 24.9 mm x 18.7 mm / 0.98" x 0.74")

⁶ Horizontal angle of view for a Normal 35 Academy camera
(aspect ratio 1:1.37, dimensions 22 mm x 16 mm / 0.87" x 0.63")

⁷ Horizontal angle of view for an APS-C camera
(aspect ratio 1:1.50, dimensions 22.3 mm x 14.9 mm / 0.88" x 0.59")

⁸ Horizontal angle of view for a Micro 4/3 (MFT) camera
(aspect ratio 1:1.33, dimensions 17.3 mm x 13 mm / 0.68" x 0.51")

Changing the Mount of a ZEISS CZ.2

In this chapter you learn how to change the mount of a ZEISS CZ.2. The procedure consist of 2 parts which are both mandatory to successfully change a mount. You learn how to detach the currently attached mount and how to attach a different mount. To make sure the ZEISS CZ.2 works properly, additionally complete the subsequent procedure:

[Adjusting a ZEISS CZ.2 to Your Digital Camera.](#)

Detaching a Mount

You need

- ZEISS CZ.2
- ZEISS T6 torque wrench with a torque of 0.4 Nm
alternatively: regular T6 torque wrench with a torque of 0.4 Nm
- ZEISS Interchangeable Mount Set for ZEISS CZ.2



The use of tools offered by ZEISS is highly recommended. You can purchase these tools directly from ZEISS or your trusted ZEISS dealer. See [Mount Change Accessories](#)

Requirements

- Ensure that your working space is flat and leveled, in order to prevent the lens from tilting and falling over.
- Ensure that the environment is clean and free from dust so that no dust particles enter the ZEISS CZ.2.
- Ensure that the front lens cap sits on your ZEISS CZ.2, in order to avoid scratches.

1. Place your ZEISS CZ.2 on a flat surface with the mount facing up and the serial number facing away from you.



The serial number is located at the side of the lens foot.
The serial number varies.

2. Remove the rear lens cap.



You can now see the mount.

3. With a T6 torque wrench remove the torx screws of the mount.



The black inner ring is securely fastened to the mount at the ZEISS factory and does not need to be removed.



The mount is now loose.

4. Carefully detach the mount from your ZEISS CZ.2.

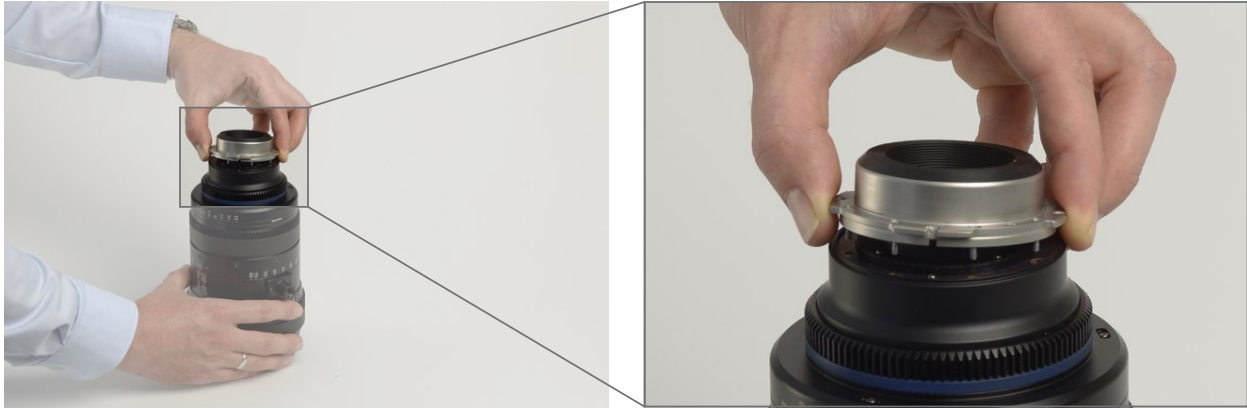

If you are changing from a PL mount, you can directly see the shims.
If you are changing from any other mount than a PL mount, you can now see the black adapter ring.



If you are changing from a PL mount, skip Step 5 and 6, since the PL mount doesn't have an adapter ring.

5. With a T6 torque wrench remove the torx screws of the black adapter ring.



The shape and height of the black adapter ring varies according to the different mounts.



The black adapter ring is now loose.

6. Detach the black adapter ring from your ZEISS CZ.2.

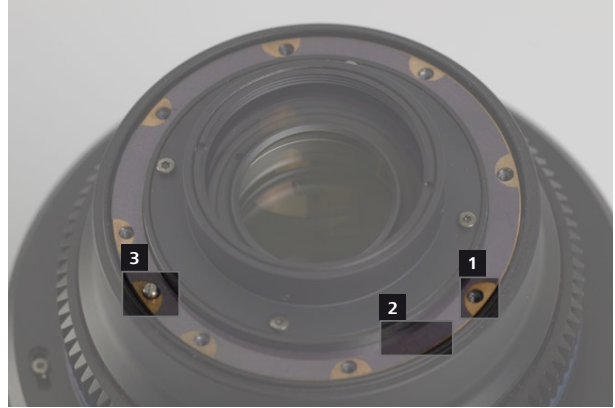

1 groove of the lens 2 shims 3 small screw in the groove of the lens



Now you see the shim(s) and a small screw in the groove of the lens barrel.
You successfully detached the mount



When detaching the mount for the first time, do not remove the shims.
Never remove the small screw in the groove of the lens.

Attaching a Mount

You need

- ZEISS CZ.2
- ZEISS T6 torque wrench with a torque of 0.4 Nm
- ZEISS Interchangeable Mount Set for ZEISS CZ.2



The use of tools offered by ZEISS is highly recommended. You can purchase these tools directly from ZEISS or your trusted ZEISS Dealer. See [Mount Change Accessories](#)

Requirements

- Ensure that your working space is flat and leveled, in order to prevent the lens from tilting and falling over.
- Ensure that the environment is clean and free from dust so that no dust particles enter the ZEISS CZ.2.
- Ensure that the front lens cap sits on your ZEISS CZ.2, in order to avoid scratches.
- Make sure you successfully completed Part 1: [Detaching a Mount](#)



If you are changing to a PL mount, skip Steps 1 and 2 in this chapter.

1. Carefully place the adapter ring, which came with your ZEISS Interchangeable Mount Set for the ZEISS CZ.2. Make sure the small screw in the groove of the ZEISS CZ.2 sinks into groove of the adapter ring.



The shape and height of the black adapter ring varies according to the different mounts.

2. With the T6 torque wrench tighten the torx screws using a torque of 0.4 N



3. Place the mount on your ZEISS CZ.2:

3.I PL mount: Place the PL mount on the ZEISS CZ.2 in such a way that the groove of the PL mount lays on top of the small screw on the lens barrel.



3.II EF mount: Place the silver EF mount on the adapter ring in such a way that the notch aligns with the aperture index mark.



3.III F mount: Place the F mount on the adapter ring in such a way that the notch aligns with the aperture index mark.



3.IV MFT mount: Place the MFT mount on the adapter ring in such a way that the notch aligns with the aperture index mark.



3.V E mount: Place the E mount on the adapter ring in such a way that the blue dot aligns with the aperture index mark.



4. With the T6 torque wrench tighten the torx screws using a torque of 0.4 N



You now successfully changed the mount of a ZEISS CZ.2.

In this chapter you learned how to detach the mount of your ZEISS CZ.2 and attach a new mount to your ZEISS CZ.2. To make sure your ZEISS CZ.2 works properly, also complete the subsequent procedure: [Adjusting a ZEISS CZ.2 to Your Digital Camera.](#)

Adjusting a ZEISS CZ.2 to Your Digital Camera

In the following chapter you learn how to adjust your ZEISS CZ.2 to a digital camera. This is necessary to ensure that the ZEISS CZ.2 works properly and delivers the maximum image quality. In order to perform this adjustment, ZEISS provides shims in different colors which indicate their thickness.

You need:

- Tripod
- Digital camera with live view
- ZEISS CZ.2 lens that needs to be adjusted
- Siemens star test chart
- Measuring tape or folding ruler
- Flat-blade screwdriver
- At least 5 m of free space
- ZEISS Interchangeable Mount Set for ZEISS CZ.2
alternatively: ZEISS Shims set



The use of tools offered by ZEISS is highly recommended. You can purchase these tools directly from ZEISS or your trusted ZEISS Dealer. See [Mount Change Accessories](#)

Requirements:

- Make sure that the front and rear lens of the ZEISS CZ.2 are clean.
- Ensure that the illumination is bright and uniform.
- Set your camera to standard settings (cf. work settings)



Smudges and fingerprints on the lens surface can gently be removed with a soft brush and then with a dry and clean cotton cloth. The ZEISS lens cleaning kit will give superior results and is highly recommended for this purpose. For further information, please watch our tutorial on how to clean your lens. <https://youtu.be/syOzecbtuwg>



Testing the Sharpness

1. Fasten the siemens star test chart on a wall.
2. Mount the ZEISS CZ.2 on the camera.
3. Mount the camera on a tripod.
4. Position your camera at a testing distance according to the [Shimming Table](#) in the appendix.



The testing distance is measured from the siemens star test chart to image plane on your camera.



-
5. Level the camera.

6. Set the aperture of the ZEISS CZ.2 to T2.9 by rotating the aperture ring.



The aperture setting must not be changed during the adjustment process.

7. Activate the live view of your camera.

8. Select the maximum magnification of the live view.

9. Make sure that the center of the image aligns with the center of the siemens star test chart.

10. Set the focal distance of the ZEISS CZ.2 to longest focal length by rotating the zoom ring.

11. Set the focus ring according to the testing distance. See [Shimming Table](#)

12. Turn the focus ring to determine if the sharpness is located below or above the testing distance.



This will give you an idea if you need to reduce or enlarge the distance of the camera to the siemens star test chart. You will need this information in a further step.

If you achieve the maximum sharpness at the testing distance according to the shimming tables, you successfully tested your ZEISS CZ.2. No further steps are required.

13. Again, set the focus ring according to the testing distance. See [Shimming Table](#)

14. Reduce or enlarge the distance between the test chart and the image plane of the camera by a maximum of 5 cm or 2" to obtain maximum image sharpness on the live view. Keep the focus ring at the testing distance.

See [Shimming Table](#)

- If you measured the sharpness below the testing distance you need to reduce the distance between the test chart and the image plane of the camera.
- If you measured the sharpness above the testing distance you need to enlarge the distance between the test chart and the image plane of the camera.



15. Now remeasure the testing distance between the image plane mark on the camera body and the test chart (= the actual distance)

- If the testing distance has changed, note the distance. The change indicates that the flange focal distance of the ZEISS CZ.2 must be adjusted. Proceed with the steps in [Correcting the Flange Focal Distance](#).



Do not take down the setup as you will need it again to recheck the sharpness later in the process.

Correcting the Flange Focal Distance

1. Remove the ZEISS CZ.2 from the camera.
2. Follow the steps of chapter [Detaching a Mount](#).
3. Determine the total thickness of the shims that already lay in the lens groove.
4. Increase or decrease the total shim thickness according to the tables in the appendix. See [Shimming Table](#)



Any combination of shims is possible to achieve the required thickness and therefore the desired flange focal distance. Always use the closest possible combination of shims.

Example: Using a ZEISS CZ.2 28–80 with an PL mount, scaled in feet and a siemens star test chart at a test distance of 7 ft, an actual distance of 7 ft 2' is measured. Due to the shimming tables, you add a orange shim 0.102 mm to the total thickness of the shims.

5. Use a flat-bladed screwdriver or a pair of tweezers to remove or add shims.



Handle the shims carefully as they can easily kink or tear which makes them unusable. Ensure that the colored shims lie on top of each other in the groove of the lens barrel and do not cover the screw holes. The shims might otherwise be damaged, while screwing in the screws.

6. Follow the steps of chapter [Attaching a Mount](#) to attach a new mount.











7. echeck the sharpness of the lens by following the steps of chapter [Testing the Sharpness](#) once more. Check the sharpness at the longest and the shortest focal length.

- a. If the testing distance has changed, follow the steps of chapter [Correcting the Flange Focal Distance](#) once more.
- b. If you achieve the maximum sharpness over the whole focal range, you successfully tested your ZEISS CZ.2.

In this chapter you learned how to adjust a ZEISS CZ.2.

Appendix

Color Code of the Shims

Shim color	Thickness [mm]	
Silver	0.013	
Gold	0.019	
Purple	0.025	
Light Blue	0.032	
Red	0.038	
Blue	0.051	
White	0.064	
Green	0.076	
Orange	0.102	
Light Purple	0.127	
Clear	0.152	

Shimming Table

Minus sign: Enlarge the flange focal distance. → Remove Shims

Plus sign: Reduce the flange focal distance. → Add Shims

Compact Zoom CZ.2 70–200/T2.9

Meter distance scale		Feet distance scale	
Distance to test chart [mm]	4500	Distance to test chart [ft]	15
Object distance at best focus [mm]	Change of total washer thickness [mm]	Object distance at best focus [ft]	Change of total washer thickness [mm]
4460	-0,09	14ft 10'	-0,11
4470	-0,07	14ft 10 1/2'	-0,08
4480	-0,04	14ft 11'	-0,06
4490	-0,02	14ft 11 1/2'	-0,03
4500	0,00	15ft 0'	0,00
4510	+0,02	15ft 1/2'	+0,03
4520	+0,04	15ft 1'	+0,06
4530	+0,07	15ft 1 1/2'	+0,08
4540	+0,09	15ft 2'	+0,11

Compact Zoom CZ.2 28–80/T2.9

Meter distance scale		Feet distance scale	
Distance to test chart [mm]	2000	Distance to test chart [ft]	7
Object distance at best focus [mm]	Change of total washer thickness [mm]	Object distance at best focus [ft]	Change of total washer thickness [mm]
1960	-0,07	7ft 10'	-0,10
1970	-0,06	7ft 10 1/2'	-0,07
1980	-0,04	7ft 11'	-0,05
1990	-0,02	7ft 11 1/2'	-0,02
2000	0,00	7ft 0'	0,00
2010	+0,02	7ft 1/2'	+0,02
2020	+0,04	7ft 1'	+0,05
2030	+0,06	7ft 1 1/2'	+0,07
2040	+0,07	7ft 2'	+0,10

Compact Zoom CZ.2 15–30/T2.9

Meter distance scale		Feet distance scale	
Distance to test chart [mm]	1000	Distance to test chart [ft]	4
Object distance at best focus [mm]	Change of total washer thickness [mm]	Object distance at best focus [ft]	Change of total washer thickness [mm]
960	-0,06	3ft 10'	-0,04
970	-0,04	3ft 10 1/2'	-0,03
980	-0,03	3ft 11'	-0,02
990	-0,01	3ft 11 1/2'	-0,01
1000	0,00	4ft 0'	0,00
1010	+0,01	4ft 1'	+0,01
1020	+0,03	4ft 1 1/2'	+0,02
1030	+0,04	4ft 2'	+0,03
1040	+0,06	4ft 2 1/2'	+0,04

Mount Change Accessories

Accessories	ZEISS Identification Number
Interchangeable Mount Set EF (CZ.2 70–200/T2.9)	2002-824
Interchangeable Mount Set EF (CZ.2 28–80/T2.9)	2016-087
Interchangeable Mount Set EF (CZ.2 15–30/T2.9)	2075-923
Interchangeable Mount Set PL (CZ.2 70–200/T2.9)	2002-823
Interchangeable Mount Set PL (CZ.2 28–80/T2.9)	2016-086
Interchangeable Mount Set PL (CZ.2 15–30/T2.9)	2075-926
Interchangeable Mount Set F (CZ.2 70–200/T2.9)	2002-825
Interchangeable Mount Set F (CZ.2 28–80/T2.9)	2016-448
Interchangeable Mount Set F (CZ.2 15–30/T2.9)	2075-924
Interchangeable Mount Set MFT (CZ.2 70–200/T2.9)	2002-826
Interchangeable Mount Set MFT (CZ.2 28–80/T2.9)	2016-449
Interchangeable Mount Set MFT (CZ.2 15–30/T2.9)	2075-925
Interchangeable Mount Set E (CZ.2 70–200/T2.9)	2002-827
Interchangeable Mount Set E (CZ.2 28–80/T2.9)	2016-450
Interchangeable Mount Set E (CZ.2 15–30/T2.9)	2075-922
Support Bracket EF, F, MFT, E (incl. screws)	1856-667
Torx torque wrench (T6, torque moment 0,4 Nm)	0520-065
Front Lens Cap Focal Lengths 18–85 mm & 100 mm CF	0097-227
Rear Lens Cap EF	1793-167
Rear Lens Cap PL	102160-0052-000
Rear Lens Cap F	1793-178
Rear Lens Cap MFT	1889-118
Rear Lens Cap E	1907-145
ZEISS Siemens Star Test Chart	1849-755
Set of Colored Shims CP.2	1853-634

Glossary

Flange focal distance	flange-to-film distance, flange focal depth, flange back distance, flange focal length
Shim	washer
Index mark	aperture indicator, aperture line, aperture mark, aperture index
Flat-blade screwdriver	slotted screwdriver, flathead screwdriver

Carl Zeiss AG
Camera Lenses
73446 Oberkochen
Germany

Phone +49 7364 20-6175
Fax: +49 7364 20-4045
www.zeiss.com/cine

EN_10_070_0003I Printed in Germany CZ-VIII/2017
Subject to change in design and scope of delivery and as a result of ongoing technical development.