

CINE RT RANGER/TRACKER SYSTEM UBS-100 OPERATION GUIDE

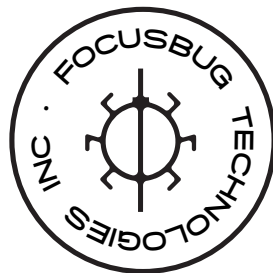

DRAFT COPY - NOT FOR DISTRIBUTION
r 1.22

TABLE OF CONTENTS

| | |
|--|----|
| COMPLIANCE STATEMENTS | 4 |
| SAFE OPERATION GUIDELINES | 5 |
| I - SYSTEM INTRODUCTION | 7 |
| II - ULTRASONIC BASE UNIT..... | 8 |
| BASE UNIT SETUP..... | 8 |
| BASE UNIT INTERNAL SETTINGS | 10 |
| ONBOARD FUNCTIONS..... | 12 |
| III - HIGH BRIGHT DISTANCE DISPLAY | 14 |
| HIGH-BRIGHT SETUP..... | 15 |
| HIGH-BRIGHT INTERNAL SETTINGS | 15 |
| HIGH-BRIGHT ONBOARD FUNCTIONS | 17 |
| HIGH-BRIGHT ALERTS..... | 19 |
| IV - BUG ULTRASONIC TRANSMITTER | 20 |
| BUG SETUP..... | 20 |
| BUG STARTUP LED SEQUENCE | 21 |
| BUG OPERATIONS | 21 |
| BUG OFFSET | 22 |
| POWER DOWN | 23 |
| BUG PERFORMANCE TIPS | 24 |
| V - HANDSET CONTROL UNIT | 25 |
| HANDSET SETUP | 26 |
| RANGER (RANGEFINDER) MODE SCREEN..... | 27 |
| BUG MODE SCREEN | 34 |
| TAPE MODE SCREEN..... | 41 |
| VITALS MENU SCREEN | 45 |
| 2X VIEW SCREEN | 51 |
| RANGER LIMITS SCREEN | 53 |
| RANGER LOCKOUT SCREEN | 56 |
| SONIC ANALYSER SCREEN | 59 |
| FOCUS WHISPER SCREEN | 62 |
| MARKS EDITOR SCREEN | 65 |
| QUICK MARK EDITOR SCREEN | 69 |
| SYSTEM SETTINGS MENU TREE..... | 71 |
| SETTINGS MENU | 73 |
| RF MENU..... | 77 |

| | |
|---|-----|
| DSP (DIGITAL SIGNAL PROCESSING) MENU | 79 |
| BUG SETTINGS MENU | 81 |
| ADVANCED SYSTEM SETTINGS MENU | 84 |
| VI - SYNC MODE & LONG RANGE OPERATION | 88 |
| VII - CINE-TAP MODE | 91 |
| APPENDIX A - INTERNAL SETTINGS QUICK GUIDE | 92 |
| BASE: INTERNAL SETTINGS QUICKCHART | 92 |
| BASE: ON-BOARD FUNCTIONS QUICK REFERENCE | 92 |
| HIGH-BRIGHT: INTERNAL SETTINGS QUICKCHART | 93 |
| HIGH-BRIGHT: ON-BOARD FUNCTIONS QUICK REFERENCE | 93 |
| BUG STARTUP LED SEQUENCE QUICK REFERENCE | 94 |
| APPENDIX B - QUICK START GUIDE, BASIC | 95 |
| APPENDIX C - LIMITS AND LOCKOUTS, TECHNICAL NOTES | 96 |
| APPENDIX D - MULTIPLE SYSTEMS OPERATION | 97 |
| FAQs AND TROUBLESHOOTING GUIDE | 100 |
| TECHNICAL SPECIFICATIONS | 104 |

COMPLIANCE STATEMENTS

INDUSTRY CANADA EMISSION COMPLIANCE STATEMENTS

This device complies with Industry Canada license-exempt RSS standards RSS 210. Operation is subject to the following two conditions: (1) this device may not cause interference, and (2) this device must accept any interference, including interference that may cause undesired operation of the device.

This Class A digital apparatus complies with Canadian ICES-003.

Le présent appareil est conforme aux CNR d'Industrie Canada applicables aux appareils radio exempts de licence. L'exploitation est autorisée aux deux conditions suivantes : (1) l'appareil ne doit pas produire de brouillage, et (2) l'utilisateur de l'appareil doit accepter tout brouillage radioélectrique subi, même si le brouillage est susceptible d'en compromettre le fonctionnement. Cet appareil numérique de la classe A conforme à la norme NMB-003 du Canada.

- 1) This device may not cause harmful interference, and
- 2) This device must accept any interference that may cause any undesired operation.

Caution: Changes or modifications to this equipment, not expressly approved by the manufacturer could void the user's authority to operate the equipment.

FEDERAL COMMUNICATIONS COMMISSION(FCC) STATEMENTS



Note: This equipment has been tested and found to comply with the limits for a Class A digital device, pursuant to part 15 of the FCC Rules. These limits are designed to provide reasonable protection against harmful interference when the equipment is operated in a commercial environment. This equipment generates, uses, and can radiate radio frequency energy and, if not installed and used in accordance with the instruction manual, may cause harmful interference to radio communications. Operation of this equipment in a residential area is likely to cause harmful interference in which case the user will be required to correct the interference at his own expense.

This equipment complies with FCC Rules, Part 15 for a Class A Digital Device. Operation is subject to two conditions:

SAFE OPERATION GUIDELINES

LASER SAFETY WARNING:



The Base Unit (UBS-100) contains a Class 3R/ IIIA Targeting Laser. A Class 3R laser is considered safe if handled carefully with restricted beam viewing. Locate and identify the marked Laser Aperture BEFORE powering up the device. Avoid direct eye exposure and do NOT stare directly into the laser beam. DO NOT aim the beam at others unless protective eyewear or other precautions are taken.

SAFETY INSTRUCTIONS - PLEASE READ!

- DO NOT supply any component in the system with a voltage exceeding it's rated maximum voltage!! Damage to the device may occur. Minimum & maximum input voltages are labelled on each device and are provided here for reference.

Base (UBS-100): 9 - 30V DC

Handset (HSU-100): 7 - 20V DC

High-Bright Display (HBD-100): 7 - 20V DC

Bug Miniature tx (BUG-100): 5V DC (USB)

- DO NOT use the Cine RT system in the rain or under other conditions with high moisture without appropriate protection.

- DO NOT expose the devices to excessive vibration or impact. Be careful not to drop any part of the Cine RT system. Internal mechanisms may be damaged by severe shock.

- The use of other devices using radio or other communication waves may result in interference with the Cine RT system's proper working. If system performance is affected by a device in it's proximity, separate the devices or attenuate the level of radio communication

signals on the interfering device.

- Clean only using a dry or slightly damp cloth. DO NOT rinse or immerse any element of the system. DO NOT use soaps, detergents, ammonia, alkaline cleaners and/or abrasive cleaning compounds or solvents.

- DO NOT blow forced air into any of the ultrasonic transducer grilles. The transducers may be damaged and compromise the functioning of the device.

- This system contains NO user-serviceable parts. DO NOT disassemble any part of the system. All repairs and alterations should be made by Focusbug Technologies Inc. or a licensed repair facility.

- The internal batteries of any part of the Cine RT system are NOT user-servicable or replaceable. All modifications should be made by Focusbug Technologies Inc. or a licensed repair facility.

- DO NOT store near any heat sources such as radiators, heat registers, stoves, or other apparatus that produce heat. Avoid exposure to temperature extremes, damp, severe vibration, strong magnetic fields or long exposures to direct sunlight during storage.

BATTERY CARE & STORAGE

The Cine RT system Handset (HSU-100), High-Bright LED display (HBD-100) and BUG miniature Ultrasonic Transmitter (BUG-100) contain integrated internal lithium-ion batteries. While these batteries provide superior power characteristics with minimal weight, they do require some basic care. Following the guidelines below will improve battery life and performance.

- Lithium-ion batteries have no "memory" and no scheduled cycling is required. There is no need to discharge the batteries to any specific level before charging. Top-up charging during regular use has no adverse effects.

- It is recommended to charge/discharge the batteries to 35% to 60% charge before long-term storage of any of the devices with internal batteries.

- Lithium-ion batteries will self-discharge over time. For long term storage ensure that batteries remain at approx. 35% to 60% charge.
- DO NOT store batteries in a fully discharged state for long periods of time.
- Storing devices with internal batteries fully charged or in high temperature conditions may permanently reduce the life of the battery. Available battery capacity may also be temporarily lessened after storage in low temperature conditions.

I - SYSTEM INTRODUCTION

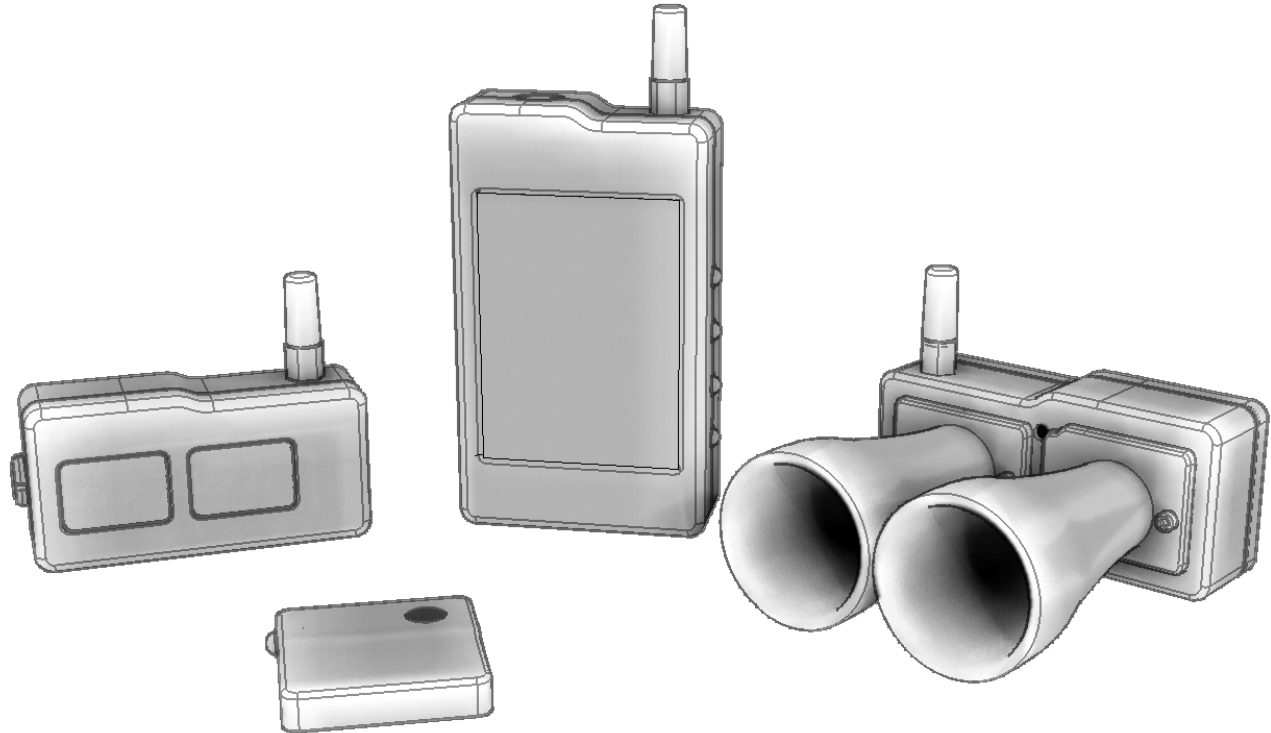

The CINE RT SYSTEM re-imagines traditional camera mounted range finder systems using cutting-edge computing solutions to provide camera assistants with innovative and practical user modes and functions. Precision clocking and high sample rates ensure continuous accurate measurements, while proprietary algorithms work to offer an exceptional balance of sensitivity and stability. High-quality construction out of CNC machined aluminum and advanced thermoplastics provides rugged, durable and stylish functionality suited to the rigours of modern film production.

The ULTRASONIC CINE RT SYSTEM is composed of 4 separate components:

- **ULTRASONIC BASE UNIT:** Mounts on the camera & houses the ultrasonic Tx and Rx elements.
- **HANDSET CONTROL UNIT:** Handheld control and display unit accesses advanced functions.
- **HIGH-BRIGHT DISTANCE DISPLAY:** High Contrast LED distance readout.
- **BUG ULTRASONIC TRANSMITTER:** A miniature, wearable ultrasonic transmitter.

II - ULTRASONIC BASE UNIT

The lightweight ULTRASONIC BASE UNIT sets up with ease, using a versatile mounting system on the back of the unit which allows the device to be configured with a low profile. The system is designed to add as little weight and clutter to the camera build as possible.

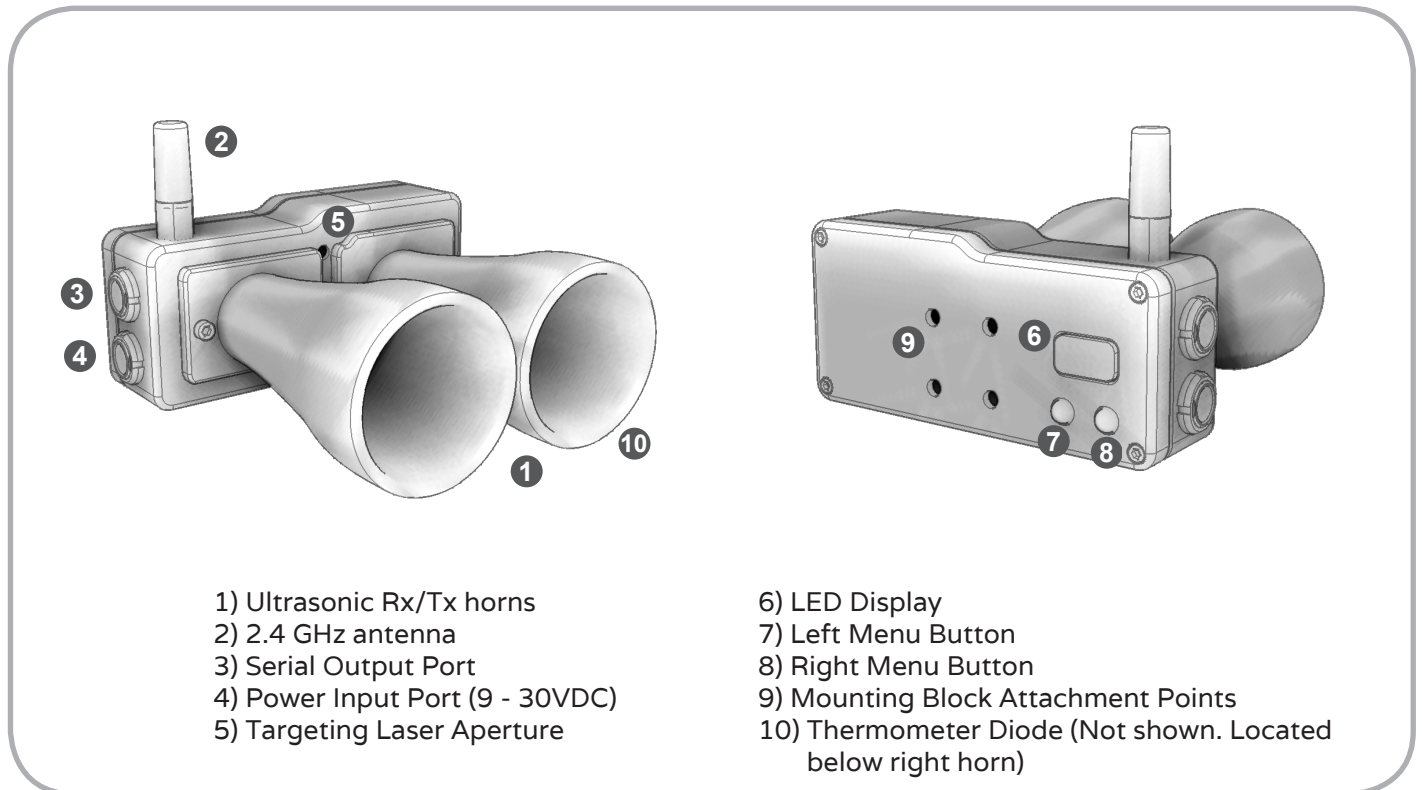

BASE UNIT SETUP

STEP ONE - Mount the BASE on the camera using one of the MOUNTING BLOCKS included with your system kit.

STEP TWO - Power the BASE with the LEMO POWER CABLE included with your system kit. The POWER INPUT is found on the bottom right side of the BASE directly under the SERIAL OUTPUT connector.

Important: The BASE unit runs on DC power between 9 and 30V. Input voltages over 30 Volts might cause permanent damage to the BASE unit! Also ensure that the input polarity is

correct for the supplied voltage source. Pin 1 = Ground. Pin 2 = Hot (+VDC).

Note: If possible, power the ULTRASONIC BASE UNIT before the other devices in the system. The HIGH-BRIGHT DISPLAY, HANDSET and BUG ULTRASONIC TRANSMITTER will not be fully operational until the BASE is powered.

STEP THREE - Ensure that the Protocol ID and RF channel settings are set correctly to function with other system components. See [BASE UNIT INTERNAL SETTINGS](#) section for more details.

STEP FOUR - The CINE RT System is able to send target distance information to a Preston handset, ARRI WCU-3/4 or other compatible device. If desired, connect the optional SERIAL CABLE to the SERIAL OUTPUT PORT located on the top right side of the BASE above the POWER INPUT and connect the other end to the serial port of the desired device. When powered, the BASE will start sending distance information based on the last used mode and settings.

Note: The SERIAL OUTPUT protocol is selectable through the HANDSET in the SETTINGS MENU.

Important: The SERIAL CABLE is not reversible. Ensure that the end labelled "Cine RT" is connected to the ULTRASONIC BASE UNIT.

STEP FIVE - In regular operation, the BASE powers up with the FILM PLANE OFFSET ("FP") displayed on the LED DISPLAY located on the back right side of the unit.

Use the RIGHT and LEFT MENU BUTTONS to adjust ONBOARD FUNCTIONS (FILM PLANE OFFSET, SENSITIVITY or TARGETING LASER) as required. See [BASE ONBOARD FUNCTIONS](#) section for more details.

BASE UNIT INTERNAL SETTINGS

Protocol ID ('A' or 'B' camera setting), Radio Channel and other functions can be adjusted via the INTERNAL SETTINGS menu on the BASE.

To view or change the INTERNAL SETTINGS, press and hold the RIGHT MENU BUTTON as you plug the BASE in. Release the button when you see the character "P_A" or "P_B" appear on the LED DISPLAY. Toggle through the INTERNAL SETTINGS by pressing the LEFT MENU BUTTON and adjust each setting by pressing the RIGHT MENU BUTTON to toggle through the options.

Note: If the BASE has been put into "CINE-TAP" MODE, the LED DISPLAY will read "LT" for a few seconds on power up. In this mode, the INTERNAL SETTINGS menu is disabled and regular functions are changed for compatibility with older rangefinder systems. [See the CINE-TAP MODE section of this manual for more information.](#)

Note: Holding BOTH MENU BUTTONS as the BASE is plugged in will restore BASE factory defaults, display the firmware version, and then enter the INTERNAL SETTINGS menu.

[*A quick reference flowchart of the INTERNAL SETTINGS menu is located in Appendix A.](#)

PROTOCOL ID SETTING ("P")

Assigns the base unit ID for use in multi-unit setups. For example: assign the "A" camera's BASE to Protocol ID "A" and the "B" camera's BASE to Protocol ID "B" . ([See SYNC MODE section for more details](#)).

Select "A" (factory default) or "B" as your BASE's default PROTOCOL ID. If only one CINE RT System is in use, select "A".

Important: All devices in your system should be set to the same PROTOCOL ID!!

Note: This setting must be made on the BASE and cannot be adjusted remotely by the HANDSET. Other system components will need to be individually set to the same PROTOCOL ID for proper operation.

RF CHANNEL SETTING ("L")

Assigns a radio frequency channel to the BASE to prevent radio crosstalk with other CINE RT SYSTEMS in the area.

Important: All devices in your system should be set to the same RF CHANNEL!!

For multi-unit setups, both “A” and “B” systems should be set to the same RF CHANNEL. (See SYNC MODE section for more details).

Select channel “ 1” (factory default), “ 2” or “ 3” as your BASE’s RF channel.

Note: This setting must be made on the BASE and cannot be adjusted remotely by the HANDSET. Other system components will need to be individually set to the same RF CHANNEL for proper operation.

SYNC MODE SETTING (“ 5”)

Activates SYNC MODE operation to avoid ultrasonic crosstalk when two CINE RT SYSTEMS are working in close proximity on the same set. See SYNC MODE section of manual for more information.

Select “ 0” (factory default) for SYNC MODE OFF and “ 1” for SYNC MODE ON.

Note: This setting can be adjusted remotely from the HANDSET and will be saved to the BASE memory as a default.

UNITS SETTING (“ 4”)

Assigns the BASE measurement units. Select “ 1” for Imperial (feet/inches) and “ 2” for Metric (meters/centimeters).

Important: When the UNITS SETTING is changed, all FILM PLANE and BUG OFFSETS are returned to zero.

Note: This setting can be adjusted remotely from the HANDSET and will be saved to the BASE memory as a default.

Note: The HIGH-BRIGHT units have separate UNIT SETTING menus and needs to be set independently of the BASE. See HIGH-BRIGHT INTERNAL SETTINGS for details.

EXTERNAL SERIAL OUTPUT (“ E”)

Assigns the format of the SERIAL OUTPUT port. Select “ EP” for Preston Native protocol for the MDR 3/4 or “ E1” (factory default) for “Classic” protocol for compatibility with other devices.

Note: This setting can be adjusted remotely from the HANDSET and will be saved to the BASE memory as a default.

ONBOARD FUNCTIONS

The LEFT and RIGHT MENU BUTTONS can be used at any time during normal operation to adjust the FILM PLANE OFFSET and SENSITIVITY values and to control the integrated TARGETING LASER.

FILM PLANE OFFSET (“FP”)

When the BASE is powered and running in normal operation, the FILM PLANE OFFSET value is displayed on the LED DISPLAY located on the back right side of the unit. Press and release the RIGHT MENU BUTTON to increase the FILM PLANE OFFSET and the LEFT MENU BUTTON to decrease it.

Setting the Film Plane Offset

The FILM PLANE OFFSET (FPO) setting ensures measurement readings are calibrated to the camera’s film plane. A value of “00” indicates that the FILM PLANE OFFSET is set for the back of the BASE unit case.

To calibrate the BASE to the camera’s film plane, measure the distance from the camera’s film plane to the back of the BASE unit’s case and enter the distance as the FILM PLANE OFFSET (FPO) with the MENU BUTTONS. If the BASE is located in front of the camera film plane, the FPO should be a positive value. If the BASE is located behind the camera film plane the FPO should be a negative value.

Note: The FILM PLANE OFFSET value is displayed in inches if the UNITS SETTING is set to Imperial, and centimetres if the UNITS SETTING is set to metric.

Note: Due to the 2 digit LED display limit, FILM PLANE OFFSET values below -9 will be displayed with a trailing decimal point to indicate a negative value. For example, a FILM PLANE OFFSET value of -15 will read as “15”

Note: This setting can be adjusted remotely from the HANDSET and will be retained in the BASE memory as a default.

Alternate Method

Like other ultrasonic rangefinders, the FILM PLANE OFFSET may also be adjusted by acquiring an ultrasonic distance reading from a hard target at a known distance. Adjust the FILM

PLANE OFFSET value on the BASE until the distance displayed on the HIGH-BRIGHT and/or the HANDSET matches the actual distance between the camera's film plane and the target. Matching distance information means the FILM PLANE OFFSET has been correctly adjusted.

SENSITIVITY ("5n")

Adjusts the trigger threshold for the BASE's ultrasonic receiver. Press and hold the LEFT MENU BUTTON until "5n" is displayed. Release the BUTTON and the current sensitivity value will display. Adjust the value using the RIGHT and LEFT MENU BUTTONS.

The CINE RT default baseline value of 50 is a functional average balanced for general use. Raising the value will allow the the BASE to locate smaller targets over greater distance but may increase false triggers of unwanted targets in the same space. Lowering the value will reduce the chance of false triggers but may decrease the ability of the BASE to register small targets at greater distance.

Note: The BASE will revert to displaying the FILM PLANE OFFSET if no sensitivity adjustments are made within approximately 3 seconds.

Note: This setting can also be adjusted remotely from the HANDSET.

TARGETING LASER ("Lr")

The BASE contains a Class 3R/IIIA laser which allows for quick and easy subject targeting and helps to ensure that your subject is centered in the BASE ultrasonic field of view. Press and hold the RIGHT MENU BUTTON to engage the laser dot which is emitted from a clearly marked aperture on the front of the BASE. The LASER will stay on for 15 seconds. Push either the RIGHT or LEFT MENU BUTTON to turn it off immediately.

IMPORTANT: Do not stare into the laser beam or turn on the laser while pointed at anyone's eyes. A Class 3R laser is considered safe if handled carefully, with restricted beam viewing. Understand and obey all relevant warnings found at the front of this manual!

III - HIGH BRIGHT DISTANCE DISPLAY

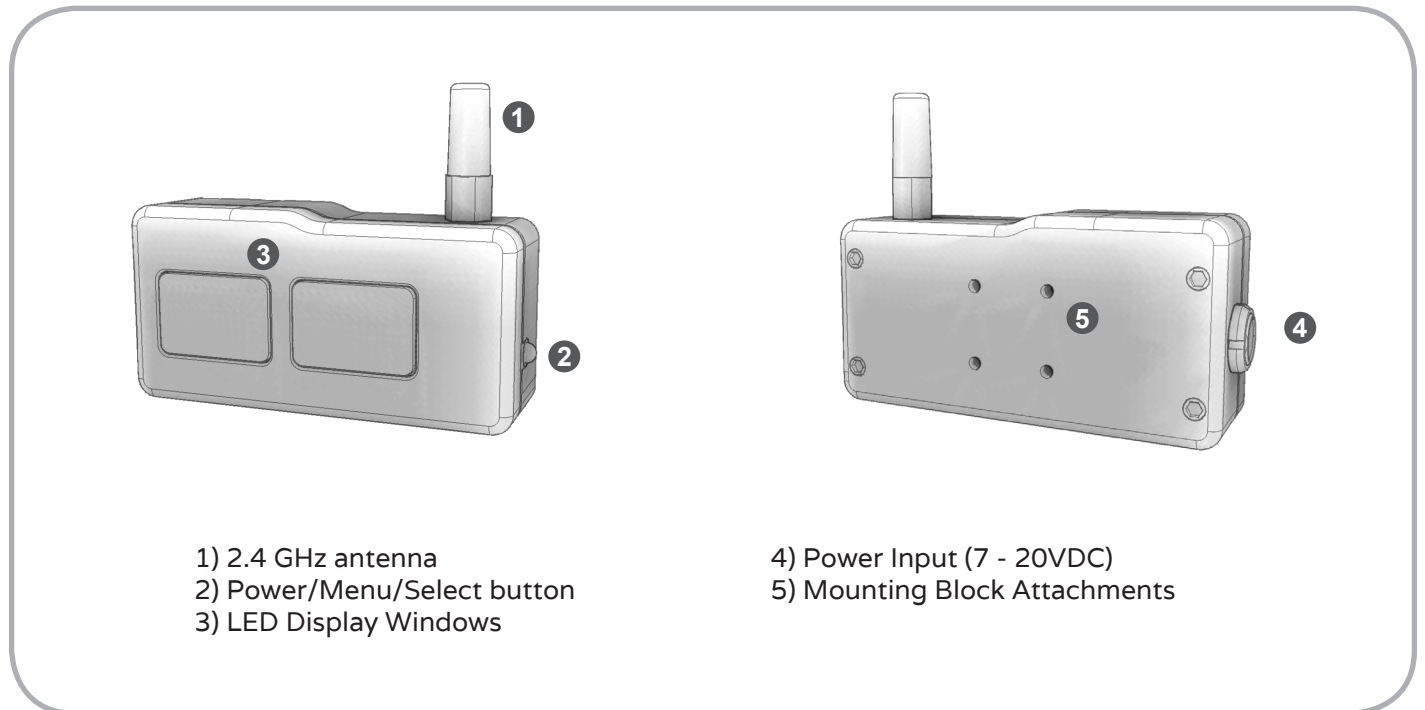

The CINE RT HIGH-BRIGHT DISTANCE DISPLAY (“HIGH-BRIGHT”) shows distance information using four ultra-bright 14mm LED characters. Five selectable levels of brightness ensure visibility under all lighting conditions.

The HIGH-BRIGHT can display information in either Imperial or Metric measurement units and will receive valid information from the BASE via RF up to 600’ (line of sight).

The HIGH-BRIGHT can be run using the rechargeable internal battery or powered externally through the POWER INPUT connector. When power is applied externally, the internal battery will automatically begin charging.

The HIGH-BRIGHT uses the same versatile mounting system as the CINE RT ULTRASONIC BASE UNIT and can be mounted with ease wherever required. Multiple HIGH-BRIGHT displays can be used simultaneously in the CINE RT ecosystem.

HIGH-BRIGHT SETUP

STEP ONE - If desired, mount the HIGH-BRIGHT using a MOUNTING BLOCK included with your system kit.

NOTE: It is possible to use two or more HIGH-BRIGHT units simultaneously to provide multiple display options, e.g., mount a HIGH-BRIGHT on the camera and another HIGH-BRIGHT beside a focus monitor. Additionally several HIGH-BRIGHT units can be configured to simultaneously monitor two separate SOURCES. See [SOURCE SETTING in the HIGH-BRIGHT INTERNAL SETTINGS menu below](#).

STEP TWO - To power up the HIGH-BRIGHT, press and hold the BUTTON located on the lower right side of the HIGH-BRIGHT. Release the button when “n” appears in the RIGHT WINDOW.

If the BASE has not yet been powered, the HIGH-BRIGHT will display the “-rF-” warning (see HIGH-BRIGHT ALERTS). If the BASE is already powered, the HIGH-BRIGHT will immediately display the distance information being transmitted by the BASE.

STEP THREE - Ensure that the Protocol ID and RF channel settings are set correctly to function with other system components. See [HIGH-BRIGHT UNIT INTERNAL SETTINGS section for more details](#).

STEP FOUR - In normal operation, use the BUTTON to adjust ONBOARD FUNCTIONS as required. See [HIGH-BRIGHT ONBOARD FUNCTIONS below for details](#).

HIGH-BRIGHT INTERNAL SETTINGS

To view or change the INTERNAL SETTINGS menu, power up the HIGH-BRIGHT as usual but continue to press and hold the BUTTON located on lower right side of the HIGH-BRIGHT after the “n” indicator appears. Release the BUTTON when “P” appears in the LEFT WINDOW. The HIGH-BRIGHT is now in the INTERNAL SETTINGS menu (see below for menu details).

Upon entering the INTERNAL SETTINGS menu, each menu item appears for approximately three seconds. Press the BUTTON to toggle the displayed setting options, or wait until the next setting is shown. The HIGH-BRIGHT will automatically exit the menu after every setting has been displayed. If no further changes are desired, simply wait until the INTERNAL SETTINGS sequence is completed and the standard distance readings appear.

*A quick reference flowchart of the INTERNAL SETTINGS menu is located in Appendix A.

PROTOCOL ID SETTING (“P”)

Pairs the HIGH-BRIGHT to a BASE with the same Protocol ID See [BASE UNIT INTERNAL SETTINGS MENU](#) for details.

Select “P” (factory default) or “b” as your HIGH-BRIGHT unit’s default PROTOCOL ID.
Important: All devices in your system should be set to the same PROTOCOL ID!!

Note: This setting must be made on the HIGH-BRIGHT and cannot be adjusted remotely by the HANDSET.

RF CHANNEL SETTING (“Ch”)

This setting aligns the HIGH-BRIGHT’s 2.4 GHz receiver to a CINE RT SYSTEM’s selected operational Radio frequency Channel.

Select channel “1” (factory default), “2” or “3” as your rf channel to align to a BASE with the same RF CHANNEL SETTING.

Important: All devices in your system should be set to the same CHANNEL SETTING!!

Note: This setting must be made on the HIGH-BRIGHT and cannot be adjusted remotely by the HANDSET.

SOURCE SETTING (“Src”)

Sets the HIGH-BRIGHT to receive one of two SOURCES as defined in the 2X VIEW MODE on the HANDSET See [HANDSET: 2X VIEW](#) section for details.

Select “1” to display SOURCE ONE and “2” to display SOURCE TWO.

Note: If 2X VIEW MODE is not engaged on the HANDSET, any HIGH-BRIGHT set to display SOURCE 2 will be inactive and display the NO SOURCE alert (“----”).

Note: This setting must be made on the HIGH-BRIGHT and cannot be adjusted remotely by the HANDSET.

UNITS SETTING (“Un”)

Assigns the HIGH-BRIGHT’s measurement display units.

Select “1” for Imperial (feet/inches) or “2” for Metric (meters/centimeters).

Important: This units setting is customizable for each active HIGH-BRIGHT unit and is

independent of the measurement units used by the BASE and HANDSET!

Note: This setting must be made on the HIGH-BRIGHT and cannot be adjusted remotely by the HANDSET.

FAST CHARGE SETTING (“FL”)

Sets a regular or fast charging rate for the HIGH-BRIGHT.

Select “**⏻**” for REGULAR CHARGE or “**⚡**” for FAST CHARGE.

Note: Under normal operating conditions the HIGH-BRIGHT can be used in FAST CHARGE. However, in high ambient temperatures with the LED DISPLAY set to higher brightness levels, REGULAR CHARGE is recommended to avoid overheating.

Note: This setting must be made on the HIGH-BRIGHT and cannot be adjusted remotely by the HANDSET.

INVERT (FLIP) DISPLAY (“FL”)

Sets the default vertical orientation of the display

Select “**⏻**” for normal display orientation or “**⏮**” to invert the display.

Note: This setting must be made on the HIGH-BRIGHT and cannot be adjusted remotely by the HANDSET.

HIGH-BRIGHT ONBOARD FUNCTIONS

In normal operation, use the BUTTON to access the BRIGHTNESS, BATTERY INDICATOR & POWER DOWN functions.

BRIGHTNESS

Adjusts the LED brightness.

Quickly press and release the BUTTON located on the lower right side of the HIGH-BRIGHT. Each press will toggle through a range of five brightness settings.

Note: On the highest brightness setting the battery charge rate is automatically forced to REGULAR CHARGE. This is to avoid thermal stress due to the high output power of the LED DISPLAY on maximum brightness. Reducing the brightness will automatically restore the unit to FAST CHARGE if enabled in the FAST CHARGE SETTING menu. (See [FAST CHARGE SETTING above](#))

BATTERY INDICATOR

Displays the remaining internal battery life.

Press and hold the **BUTTON** located on the lower right side of the **HIGH-BRIGHT** until one or more **DOTS** appears along the bottom of the **LED WINDOWS** (or top if **INVERT DISPLAY** is set). Release the **BUTTON** when the **DOTS** appear to avoid unit shutdown (see **POWER DOWN** function below.)

The **DOTS** indicate the remaining battery life of the unit:

- 4 **DOTS** indicates a full battery charge,
- 3 **DOTS** indicates approximately 75% charge,
- 2 **DOTS** indicates approximately 50% charge,
- 1 **DOT** indicates approximately 25% charge, and
- 1 **FLASHING DOT** indicates that the **HIGH-BRIGHT** internal battery is critically low and requires immediate charging from an external power source. This will display automatically when battery reaches critically low levels.

To charge the **HIGH-BRIGHT**, connect the **LEMO POWER CABLE** included with your system to the **POWER INPUT** found on the left side of the **HIGH-BRIGHT**. While charging the **BATTERY INDICATOR** will always display 4 **DOTS**.

The battery indicator is also available when the unit is powered down. While the unit is off, quickly press and release the **BUTTON** to see the charge of the **HIGH-BRIGHT** battery. To power up the **HIGH-BRIGHT**, continue to press the **BUTTON** until “**ON**” is displayed, otherwise the **HIGH-BRIGHT** will remain powered down.

Note: Battery life time varies significantly depending on the brightness of the **HIGH-BRIGHT** unit. Using lower brightness settings will greatly increase the battery life time.

POWER DOWN

Powers down the **HIGH-BRIGHT** unit.

While the **HIGH-BRIGHT** is on, press and hold the **BUTTON** until “**OFF**” is displayed. Release the **BUTTON** and the unit will finish its power down sequence automatically.

HIGH-BRIGHT ALERTS

NO SOURCE ("----")

Warning that there is no valid SOURCE available from the base unit.

Note: In order for SOURCE 2 to be viewable on the HIGH-BRIGHT display, 2X VIEW MODE must be active on the HANDSET. [See 2X VIEW section for more information.](#)

NO RF LINK ("-rF-")

Warning that there is presently no radio link connection with the base unit.

NO TARGET ("nE")

This alert appears when the HIGH-BRIGHT is displaying distance information. NO TARGET simply means that there is no valid target within RANGEFINDER or BUG MODE range.

TAPE MODE ENGAGED ("TAPPE")

This alert appears on the HIGH-BRIGHT when the HANDSET is in TAPE MODE or MARKS EDITOR SCREEN. This is to remind the user to exit TAPE MODE for normal operation.

IV - BUG ULTRASONIC TRANSMITTER

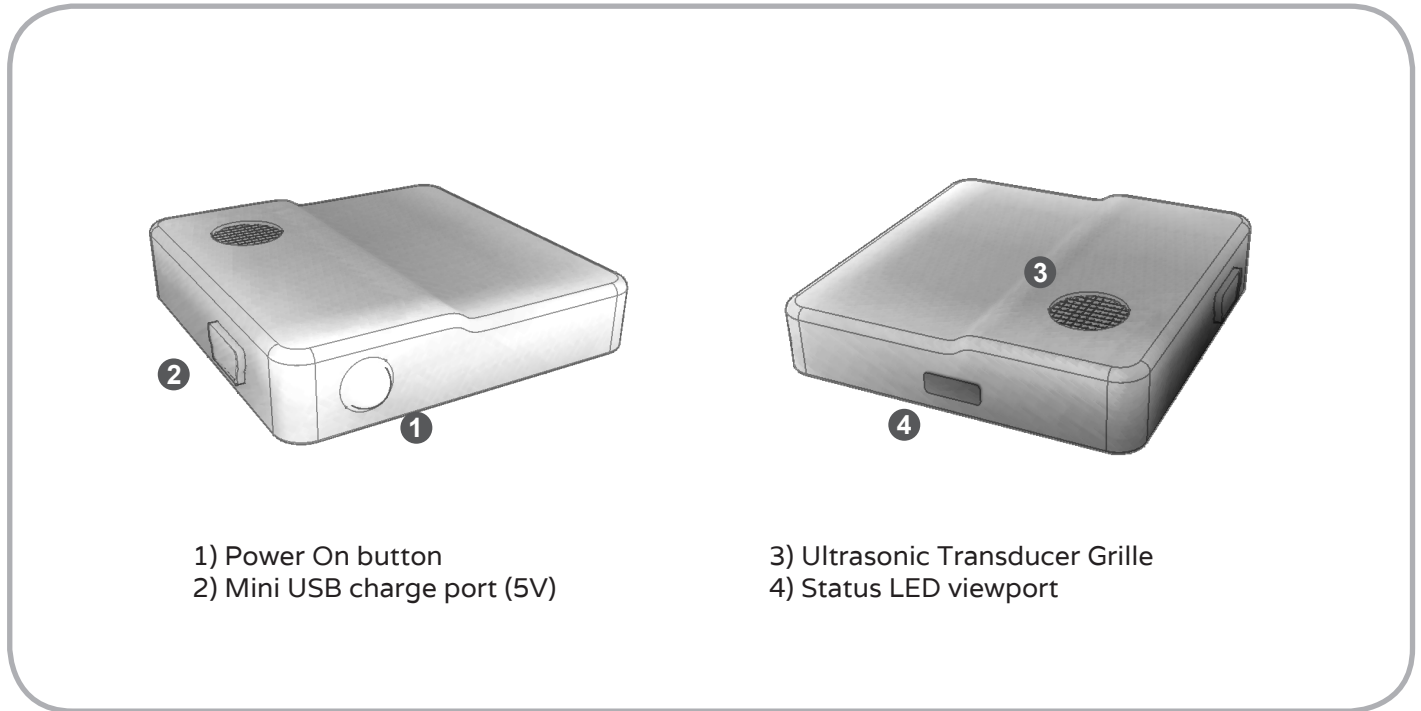

The CINE RT BUG TRANSMITTER is a miniature ultrasonic transmitter that can be used as a source for distance measurement information. The BUG works in conjunction with the BASE receiver and can be used to gather MARKS in TAPE MODE or as a real-time SOURCE placed on an actor or stand-in.

BUG status is displayed with the use of a dual LED (blue/orange) visible through the LED VIEWPORT.

The BUG transmitter can be charged by attaching a standard mini-USB connector to the CHARGE PORT on the side of the unit.

BUG distances are measured from the back of the unit. (The side opposite the transducer grille).

BUG SETUP

STEP ONE - To power on the BUG transmitter, press and momentarily hold the BUTTON

located on the transmitter. Don't release the BUTTON until after the STARTUP LED SEQUENCE is complete and the BUG's LEDs blink constantly in either ORANGE or BLUE.

Note: Releasing the BUTTON before the STARTUP LED SEQUENCE is complete will result in the BUG powering down immediately.

STEP TWO - For distance measurement using the BUG transmitter, place the active BUG in the desired location, ensuring that the ULTRASONIC TRANSDUCER GRILLE is as unobstructed as possible and facing the general direction of the BASE unit's receiving horns. The ULTRASONIC pulses emitted by the BUG need to have a clear line-of-sight to the BASE unit for accurate operation, although the unit will work around many standard on-set obstacles.

Note: If the BUG has good RF communications with the BASE, the STATUS LED (visible through the LED viewport) will flash BLUE. If no RF signals from the BASE are present, the LED will flash ORANGE.

BUG STARTUP LED SEQUENCE

On first power up, the STATUS LEDs will flash a specific sequence to indicate RF, ID and battery settings and levels.

The STARTUP LED SEQUENCE is as follows:

- The ORANGE LED will flash 1 to 3 times to indicate the BUG's current RF CHANNEL.
- The BLUE LED will flash 1 to 4 times to indicate the BUG's current BUG ID.
- The ORANGE LED will flash 1 to 4 times to indicate the unit's battery level where 1 is low battery and 4 is a fully charged battery. If the battery is critically low, the LED will remain a solid ORANGE and the BUG will shutdown automatically. In this case, the BUG will need to be charged before any further use.

BUG OPERATIONS

Once the BUG is powered on, it's communications status is shown by the STATUS LEDs. A

BLUE flash indicates good communications with the BASE while a constant ORANGE flashing indicates NO communications from the BASE unit. Occasional ORANGE flashes are expected in normal operation and are no cause for concern.

BUG operation is controlled through the HANDSET. The BUG will remain in standby mode with NO ultrasonic transmissions until one or more BUGs are selected as an active SOURCE in LIVE MODE, TAPE MODE or 2x VIEW. Once selected as an active SOURCE, the BUG will emit ultrasonic pings which are used by the BASE unit to determine the distance of the BUG from the BASE.

Note: The current FILM PLANE OFFSET (FPO) is applied to all BUG distance readings; i.e: with an FPO of "0", the distance measured is from the back of the BUG to the back of the BASE unit.

The HANDSET is also used to control the following BUG features:

BUG OFFSET

SET BUG RF CH (CHANNEL)

SET BUG ID

BUG LED CONTROL

SHUTDOWN TIMERS

DISPLAY ID

See the BUG SETTINGS MENU section in the HANDSET portion of the guide for more details on these settings.

BUG OFFSET

A separate distance offset can be applied to each BUG transmitter to compensate for placement on an actor or elsewhere. The BUG OFFSET (BGO) will be equal to the horizontal distance between the back of the BUG unit and the desired target.

A positive BGO value is used when the BUG is closer to the camera than the desired target. A negative BGO value is used when the BUG is further from the camera than the desired target. For example: A BUG is placed in the front grille of a car. There is a horizontal distance of 5'0" between the back of the BUG and the head of the car's driver. To have the CINE RT display the distance to the driver a BUG OFFSET of 5'0" should be applied to the BUG.

The BUG OFFSET feature is applied using the HANDSET and is accessed through the BUG MODE SCREEN.

POWER DOWN



Power down of the BUG is controlled via the HANDSET. The BUG also automatically shuts down if it is without RF communications from the BASE for a length of time exceeding that set in it's SHUTDOWN TIMER.

To power down the BUG unit from the HANDSET, press the KILL BUG touch key while the BUG is the active source in LIVE MODE. To power down ALL active BUGS on the current RF CHANNEL, press the KILL ALL BUGS touch key found on the VITALS SCREEN or in the BUG SETTINGS MENU.

Note: The KILL BUG touch key will power down any BUGS in RF range of the BASE which are set to the BUG ID currently displayed as the active SOURCE in LIVE MODE.

Important: The POWER ON BUTTON has no effect once the BUG is active. This is to avoid accidental shutdown and serves to make the BUG shutdown “actor-proof”.

AUTOMATIC SHUTDOWN:

Each BUG has an internal shutdown timer which is set via the HANDSET. (see SHUTDOWN TIMERS in the HANDSET menu description). BUG power-down will occur if the BUG has not received any valid RF communications from the BASE for a time exceeding the SHUTDOWN TIMER value (in hours). For example, if an active BUG has a SHUTDOWN time setting of 2 hours and has been constantly out of range of the BASE, it will power down on it's own after 2 hours has elapsed.

Note: The BUG does NOT have to be an active SOURCE for it to have valid RF communications from the BASE. While the BASE and BUG are both powered on and in RF range of each other (indicated by a BLUE flashing STATUS LED on the BUG), the SHUTDOWN TIMER countdown is NOT active.

Note: Any RF communications received by the BUG from a BASE unit will reset the SHUTDOWN TIMER countdown.

BUG PERFORMANCE TIPS

- For best reception of the BUG's ultrasonic transmissions, direct line-of-sight between the BUG and BASE unit is recommended. That said, the BUG's ultrasonic pings will usually pass around many common on-set obstacles including stands, people and props. If an obstacle is too large or blocks the receiving horn of the BASE too thoroughly, the distance readings may be affected as the signal has to travel a longer path to reach the BASE.
- The BUG can be hidden in clothing, but certain fabrics will dampen the ultrasonic signals and noticeably reduce the BUG's effective range. Heavy or tightly woven fabrics will tend to reduce the BUG's range the most, although each combination acts somewhat differently and experimentation is required for best results.
- If placed on an actor or stand-in who is turned away from camera (and the BASE unit), the distance readings provided by a BUG may jump around or become erroneous, especially at distance. The BUG unit needs direct line-of-sight to the horns to work properly and in this case the BASE is likely reading a secondary reflection of the ultrasonic ping off a wall or other surface.

V - HANDSET CONTROL UNIT

At the heart of the system Cine RT system is the touch screen HANDSET, where the full functionality of the system becomes available to the camera assistant. The HANDSET communicates remotely with the BASE to choose and monitor RANGER and BUG LIVE MODES and allows operational tools such as distance LIMITS, LOCKOUTS and VIEW options to be set. The HANDSET also functions as a measuring tool to assist in situations where marks are desired but where pulling a tape or sighting with a laser rangefinder may not be an option. The TAPE MODE allows quick and accurate distance readings to be collected by the Handset, despite typical on-set obstacles between it and the camera. Likewise, in TAPE MODE the HANDSET can work remotely with either the RANGER or BUG SOURCES to collect distance marks. Up to eight marks can be easily organized, adjusted and stored. These marks can be made visible in MARKS VIEW or made audible by the FOCUS WHISPER FUNCTION where marks are “called” via an ear bud as the target subject moves over them.

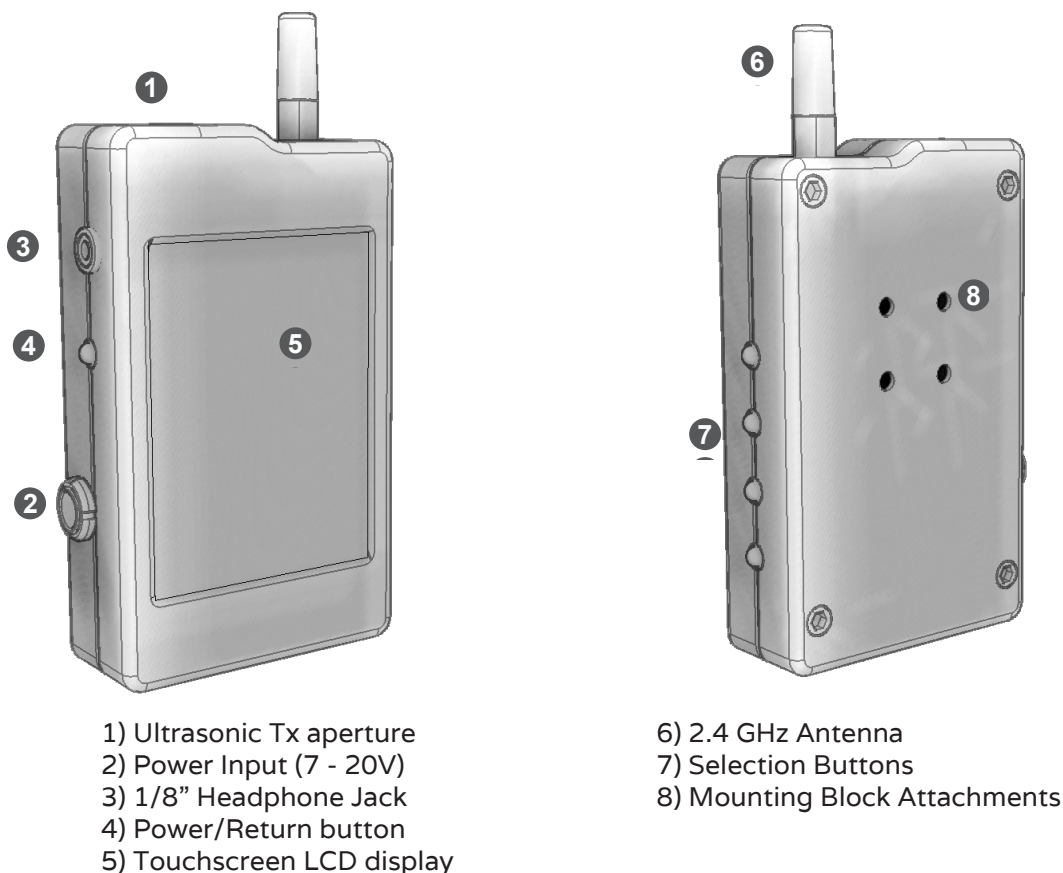

HANDSET SETUP

STEP ONE - If desired, mount the HANDSET using a mounting block included with your system kit.

STEP TWO - To turn on the HANDSET, press and hold the POWER BUTTON. Release when the start-up screen appears. If the BASE unit is powered and running, the HANDSET will switch to the LIVE MODE currently used by the BASE.

To turn the HANDSET off, press and hold the POWER BUTTON until the shutdown screen appears. Release the button and the unit will power down automatically.

STEP THREE - Ensure that the HANDSET is set to the same PROTOCOL ID and RF CHANNEL as the BASE & other components in the Cine RT system.

STEP FOUR - Choose an operational mode. The CINE RT SYSTEM has three main operational modes:

Two LIVE MODES including the rangefinder based RANGER MODE and a remote transmitter tracking BUG MODE; and a TAPE MODE where you can use the HANDSET CONTROL UNIT or select either LIVE MODE SOURCE as a tape measure to collect and store MARKS. The functionality of these MODES are further enhanced by a selection of TOOLS and VIEW options which will be detailed in each MODE section of this manual.

On power up, the HANDSET will display either of the LIVE MODE screens depending on the last used source.

MODE SELECTIONS

| | |
|--------------------|---|
| LIVE MODE - RANGER | SOURCE IS THE BASE UNIT RANGEFINDER |
| LIVE MODE - BUG | SOURCE IS A BUG MINIATURE TX |
| TAPE MODE | SOURCE IS EITHER HANDSET / RANGEFINDER or BUG |

RANGER (RANGEFINDER) MODE SCREEN

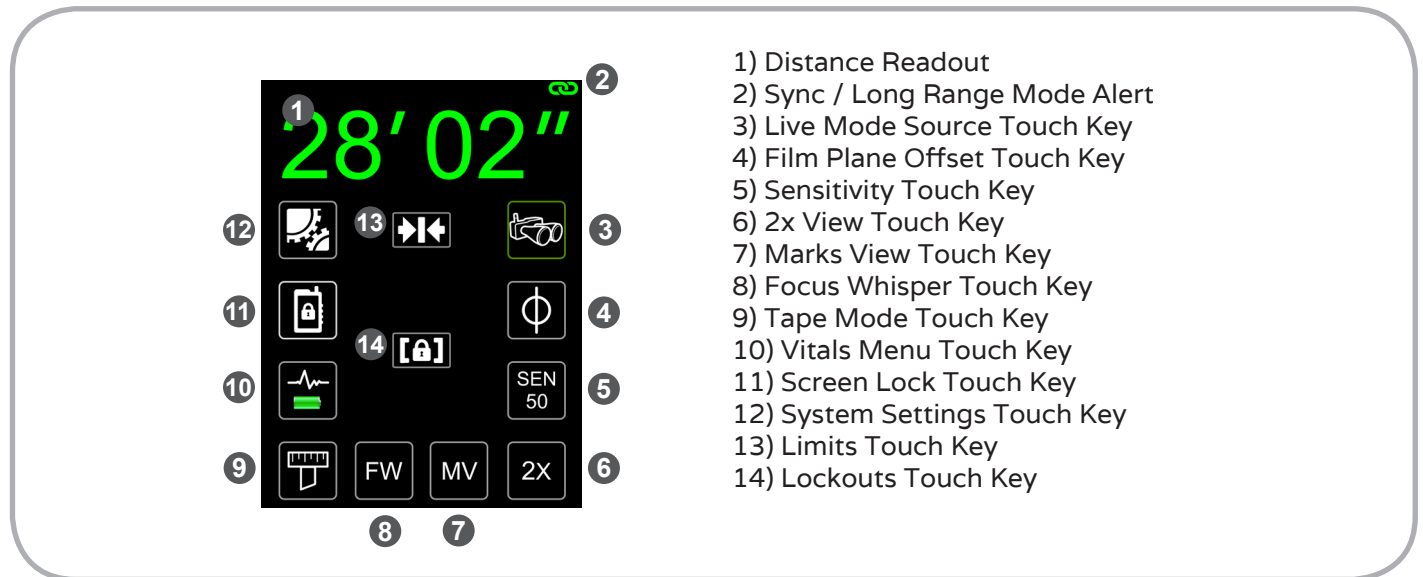

Screen Navigation

Press the TOUCH KEY or corresponding BUTTON to access: LIVE MODE SOURCE, FILM PLANE OFFSET, SENSITIVITY, TAPE MODE, 2X VIEW, FOCUS WHISPER, MARKS VIEW, VITALS MENU, SCREEN LOCK, SYSTEM SETTINGS, LIMITS, LOCKOUTS.

DISTANCE READOUT, SYNC / LONG RANGE ALERT are display features with no touch functions enabled.

DISTANCE READOUT

Displays distance data sent by the BASE, in the system's active measurement units. (See [BASE SETTINGS](#) or [HANDSET ADVANCED SYSTEMS SETTINGS](#) for information on setting the measurement units).

Note: A reading of "NT" indicates that no valid target was found in the unit's active distance range.

Note: RANGER MODE works to a maximum distance of 40' (12.2m).

SYNC MODE ALERT



If displayed, warns that the unit is currently in SYNC MODE.

Note: This alert will display in green if there is a good link with another CINE RT SYSTEM in SYNC MODE. If no link is found it will display in red.

Note: Both “A” and “B” units need to be set to SYNC MODE & the same RF CHANNEL for the synchronization link to be active.

Important: Ultrasonic sampling speeds may be reduced in this mode. See SYNC MODE section for details.

LONG RANGE ALERT



If displayed, warns that the unit is currently in LONG RANGE MODE.

Important: Ultrasonic sampling speeds will be reduced in this mode. See SYNC MODE section for details.

LIVE MODE SOURCE



Selects RANGER MODE or BUG MODE as your LIVE MODE SOURCE from which to monitor distance data.

Press to toggle between LIVE MODE SOURCES.

Important: The LIVE MODE SOURCE touch key will display a RED ICON when there is no RF connection to the BASE.

FILM PLANE OFFSET



Accesses the FILM PLANE OFFSET (FPO) menu where you can compensate for the offset between the placement of the BASE and your camera's film/focal plane.

Adjusts the FPO to ensure measurement readings are calibrated to the camera's film plane. A value of 0 ("/cm) indicates that the FPO is set for the back of the BASE unit case.

Press to enter the FILM PLANE OFFSET ADJUST page.

Setting the Film Plane Offset (FPO)

To calibrate the BASE to the camera's film plane, measure the distance from the camera's film plane to the back of the BASE unit's case and enter the distance as the FILM PLANE OFFSET (FPO) with the PLUS or MINUS TOUCH BUTTONS. If the BASE is located in front of the camera film plane, the FPO should be a positive value. If the BASE is located behind the camera film plane the FPO should be a negative value.

Alternate Method: The FILM PLANE OFFSET may also be adjusted by measuring from the camera's film plane to a hard target and then adjusting the FILM PLANE OFFSET using the PLUS or MINUS touch keys until the distance displayed on the HANDSET matches the actual distance between the camera's film plane and the hard target. Matching distance information means the FILM PLANE OFFSET has been correctly adjusted.

Note: The FILM PLANE OFFSET value is displayed in inches if the UNITS SETTING is set to Imperial, and centimetres if the UNITS SETTING is set to metric.

Note: This setting will be retained in the BASE memory as a default until set to a new value.

Note: The FILM PLANE OFFSET icon will display a green border if the FILM PLANE OFFSET is set to a non-zero value.

SENSITIVITY (RANGER TOOL)

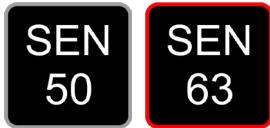

Adjusts the trigger threshold for the BASE's ultrasonic receiver for use in RANGER MODE. The CINE RT default baseline value of 50 is a functional average balanced for general use. Raising the value will allow the the BASE to locate smaller targets over greater distance but may increase false triggers of unwanted targets in the same space. Lowering the value will reduce the instance of false triggers but may decrease the ability of the BASE to register small targets at greater distance.

Press to enter the SENSITIVITY ADJUST MENU.

Note: This icon will display a red border if the current Sensitivity value doesn't match the saved default value. (i.e: a temporary sensitivity adjustment).

2X VIEW



Accesses 2X VIEW when you wish to monitor two LIVE MODE SOURCES simultaneously.

Press TOUCH KEY to enter 2X VIEW.

Note: 2x VIEW is not available if the unit is in SYNC MODE.

MARKS VIEW



Accesses MARKS VIEW, which enables real time monitoring of focus marks stored in TAPE MODE.

Press TOUCH KEY to access MARKS VIEW.

FOCUS WHISPER



Accesses the FOCUS WHISPER tool, enabling you to listen to the MARKS you have collected in TAPE MODE.

Press TOUCH KEY to access [FOCUS WHISPER](#).

Note: This icon will display a green border if FOCUS WHISPER is enabled.

TAPE MODE



Accesses the tape measure function to collect and store up to 8 focus MARKS. These marks can be adjusted in the MARKS EDITOR and used in real time in MARKS VIEW and/or FOCUS WHISPER.

Press TOUCH KEY to access [TAPE MODE](#).

Note: This icon will display a green border if any valid (non-zero) marks are stored in TAPE MODE.

VITALS MENU



Displays battery level indicator & charging status and accesses a menu of key operational alerts and LIVE MODE function quick keys.

Press TOUCH KEY to access [VITALS MENU](#) page.

SCREEN LOCK



Disables the touch screen to avoid accidental adjustments.

Press TOUCH KEY to lock touch screen. Press any physical BUTTON to unlock touch screen.

Note: This icon will display a red border if the touch screen is locked.

SYSTEM SETTINGS



Accesses the general and advanced operational menus of the HANDSET, BASE and CINE RT SYSTEM.

Press TOUCH KEY to access [SYSTEM SETTINGS page](#).

LIMITS (RANGER TOOL)



Enters the LIMITS ADJUST screen where adjustments can be made to the near and far distance LIMITS. Use this tool to set your RANGER minimum and maximum range and ignore unwanted or irrelevant near and/or far reflections.

Press TOUCH KEY to enter the [LIMITS ADJUST MENU](#).

Note: This icon will display a red border if limits have been set. The limit distance settings will also appear below the icon.

LOCKOUT (RANGER TOOL)



Enables specific regions within your LIMITS to be locked out in order to ignore unwanted reflections within your target focus area. If the RANGER becomes hung up on an object within your working range, you can LOCKOUT a segment of distance around the offending object and the RANGER will no longer “see” it, allowing you to read in front of or behind the LOCKOUT.

Press TOUCH KEY to enter the **LOCKOUT ADJUST MENU**.

Note: This icon will display a red border if a lockout has been set. The lockout distance settings will also appear below the icon.

BUG MODE SCREEN

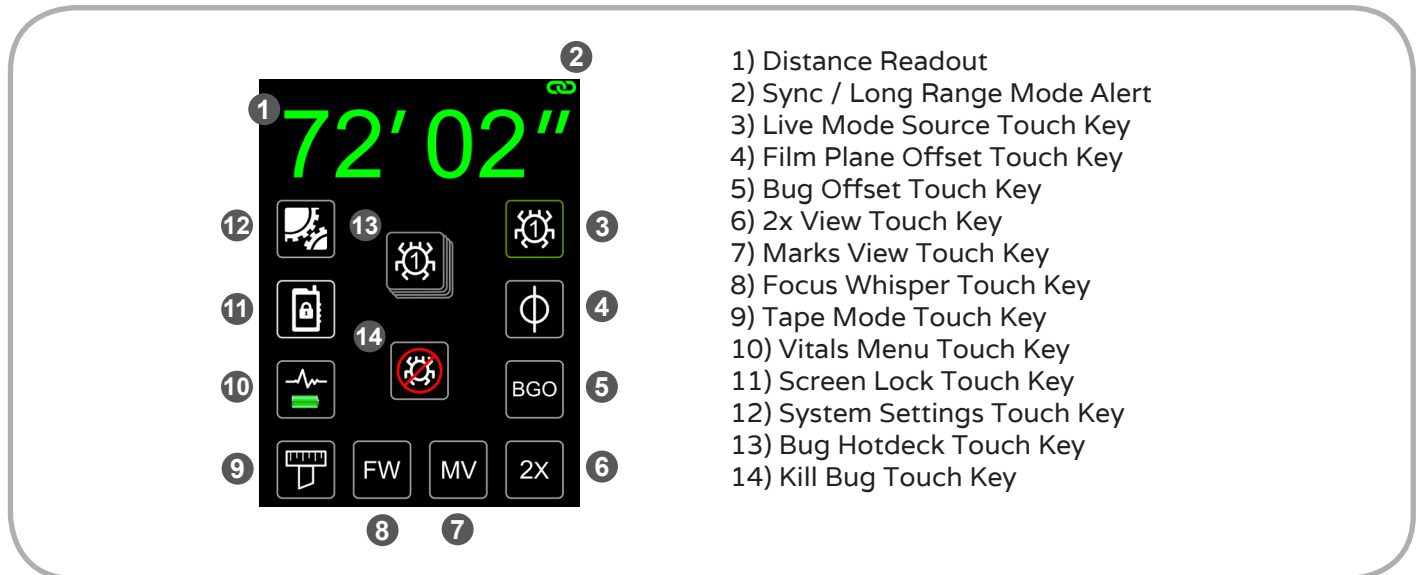

Screen Navigation

Press the TOUCH KEY or corresponding BUTTON to access: LIVE MODE SOURCE, FILM PLANE OFFSET, BUG OFFSET, TAPE MODE, 2X VIEW, FOCUS WHISPER, MARKS VIEW, VITALS MENU, SCREEN LOCK, SYSTEM SETTINGS, BUG HOTDECK, KILL BUG.

DISTANCE READOUT, SYNC / LONG RANGE ALERT are display features with no touch functions enabled.

DISTANCE READOUT

Displays distance data sent by the BASE, in the system's active measurement units. (See BASE SETTINGS or HANDSET ADVANCED SYSTEMS SETTINGS for information on setting the measurement units).

Note: A reading of "NT" indicates that the active BUG is out of range or not powered.

Note: BUG MODE works to a maximum distance of 80' (24.4m) with LONG RANGE disabled and 120' (36.5m) with LONG RANGE enabled.

SYNC MODE ALERT



If displayed, warns that the unit is currently in SYNC MODE.

Note: This alert will display in green if there is a good link with another CINE RT SYSTEM in SYNC MODE. If no link is found it will display in red.

Note: Both “A” and “B” units need to be set to SYNC MODE & the same RF CHANNEL for the synchronization link to be active.

Important: Ultrasonic sampling speeds may be reduced in this mode. See SYNC MODE section for details.

LONG RANGE ALERT



If displayed, warns that the unit is currently in LONG RANGE MODE.

Important: Ultrasonic sampling speeds will be reduced in this mode. See SYNC MODE section for details.

LIVE MODE SOURCE



Selects RANGER MODE or BUG MODE as your LIVE MODE SOURCE from which to monitor distance data.

Press to toggle between LIVE MODE SOURCES.

Important: The SOURCE TOUCH KEY will display a RED ICON when there is no RF connection to the BASE.

FILM PLANE OFFSET



Accesses the FILM PLANE OFFSET (FPO) menu where you can compensate for the offset between the placement of the BASE and your camera's film/focal plane.

Adjusts the FPO to ensure measurement readings are calibrated to the camera's film plane. A value of 0 ("/cm) indicates that the FPO is set for the back of the BASE unit case.

Press to enter the FILM PLANE OFFSET ADJUST page.

Setting the Film Plane Offset (FPO)

To calibrate the BASE to the camera's film plane, measure the distance from the camera's film plane to the back of the BASE unit's case and enter the distance as the FILM PLANE OFFSET (FPO) with the PLUS or MINUS TOUCH BUTTONS. If the BASE is located in front of the camera film plane, the FPO should be a positive value. If the BASE is located behind the camera film plane the FPO should be a negative value.

Alternate Method: The FILM PLANE OFFSET may also be adjusted by measuring from the camera's film plane to a hard target and then adjusting the FILM PLANE OFFSET using the PLUS or MINUS touch keys until the distance displayed on the HIGH-BRIGHT and/or the HANDSET matches the actual distance between the camera's film plane and the hard target. Matching distance information means the FILM PLANE OFFSET has been correctly adjusted.

Note: The FILM PLANE OFFSET value is displayed in inches if the UNITS SETTING is set to Imperial, and centimetres if the UNITS SETTING is set to metric.

Note: This setting will be retained in the BASE memory as a default until set to a new value.

Note: The FILM PLANE OFFSET icon will display a green border if the FILM PLANE OFFSET is set to a non-zero value.

BUG OFFSET



Accesses the BUG OFFSET menu where you can compensate for the offset between the position of the BUG ultrasonic transmitter and your desired target. A value of zero indicates that the back of the BUG is aligned with your desired target. See [BUG ULTRASONIC TRANSMITTER GUIDE](#) section for more details.

Press to enter the BUG OFFSET ADJUST page.

Note: This icon will display a red border if the BUG OFFSET is not set to zero.

2X VIEW



Accesses 2X VIEW when you wish to monitor two LIVE MODE SOURCES simultaneously.

Press TOUCH KEY to enter [2X VIEW](#).

Note: 2x VIEW is not available if the unit is currently in SYNC MODE.

MARKS VIEW



Accesses MARKS VIEW which enables real time monitoring of focus marks stored in TAPE MODE. (See TAPE MODE section for details.)

Press TOUCH KEY to access MARKS VIEW.

FOCUS WHISPER



Accesses the FOCUS WHISPER tool, enabling you to listen to the MARKS you have collected in TAPE MODE.

Press TOUCH KEY to access **FOCUS WHISPER**.

Note: This icon will display a green border if FOCUS WHISPER is enabled.

TAPE MODE



Accesses the tape measure options to collect and store up to 8 focus MARKS. These marks can be adjusted in the MARKS EDITOR and used in real time in MARKS VIEW and/or FOCUS WHISPER.

Press TOUCH KEY to access **TAPE MODE**.

Note: This icon will display a green border if any non-zero marks are stored in TAPE MODE.

VITALS MENU



Displays battery level indicator & charging status and accesses a menu of key operational alerts and LIVE MODE function quick keys.

Press TOUCH KEY to access the **VITALS MENU**.

SCREEN LOCK

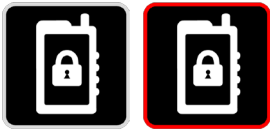

Disables the touch screen function to avoid accidental adjustments.

Press TOUCH KEY to lock touch screen. Press any physical BUTTON to unlock touch screen.

Note: This icon will display a red border if the touch screen is locked.

SYSTEM SETTINGS



Accesses the general and advanced operational menus of the HANDSET, BASE and CINE RT SYSTEM.

Press TOUCH KEY to access the [SYSTEM SETTINGS](#) page.

BUG HOTDECK



Toggles between BUG sources & updates the LIVE MODE SOURCE icon to the selected BUG.

Press TOUCH KEY to select the next available BUG. (see NUMBER OF BUGS SETTING in SYSTEM SETTINGS to change the number of selectable BUGS)

Note: An inactive or out-of-range BUG source will cause the DISTANCE READOUT to display “NT” (No Target).

KILL BUG



Sends a POWER DOWN command to the active BUG source.

Press TOUCH KEY to turn off the active selected BUG.

Note: This TOUCH KEY only applies to the BUG displayed in the LIVE MODE SOURCE icon.

i.e: if  is displayed, the KILL BUG button will only turn off BUGs set to ID 1.

Important: The selected BUG must be within RF range to respond to the POWER DOWN command.

TAPE MODE SCREEN

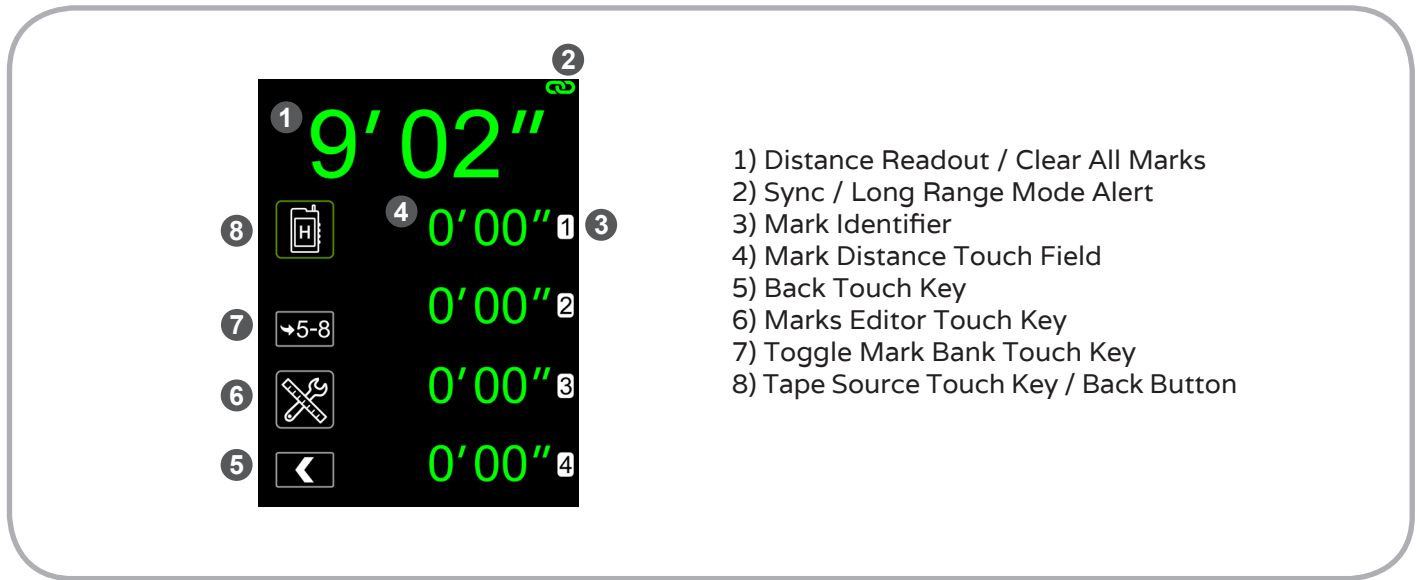

Screen Navigation

Press the TOUCH KEY or corresponding BUTTON to access: TAPE SOURCE , DISTANCE READOUT / CLEAR ALL MARKS, MARK DISTANCE, BACK, MARKS EDITOR, TOGGLE MARK BANK.

SYNC / LONG RANGE ALERT & MARK IDENTIFIER are display features with no touch functions enabled.

A single short press of the POWER BUTTON returns to LIVE MODE from this page.

TAPE SOURCE



Toggle between TAPE SOURCES. Choose HANDSET TAPE, RANGER or BUG SOURCES to provide distance information to be used in the collection of MARKS.

Press TAPE SOURCE TOUCH KEY to toggle through available SOURCES.

Note: TAPE MODE always opens with HANDSET TAPE SOURCE as a default.

Note: In the event of loss of communications with the BASE, the unit will leave TAPE MODE

automatically.

HANDSET TAPE SOURCE is a fast and accurate alternative to using a tape measure or sighting with a laser rangefinder tool to collect marks on the fly. With **HANDSET TAPE SOURCE** selected, the **HANDSET** sends an ultrasonic signal directly to the **BASE**'s sensor and, provided the **FILM PLANE OFFSET** is properly calibrated, measures directly to your camera's film plane.

When **HANDSET TAPE SOURCE** is selected, physically move to the target position you wish to use as a **MARK** and point the **HANDSET** back toward the camera (**BASE**). Reference the **DISTANCE DISPLAY** while selecting the mark. When you are happy with the distance reading, press the numbered **MARK DISTANCE TOUCH FIELD** to collect your **MARK**.

Note: The **HANDSET TAPE SOURCE** can be used to collect distances of up to 120' (36.5m) in **LONG RANGE** (or 80' (24.4m) if not in **LONG RANGE**).

Note: The displayed distance is calculated from the top edge of the **HANDSET** (the speaker grille).

RANGER SOURCE uses the **RANGER** to measure distance and is useful in situations where the camera and/or subject are moving within smaller structured/repeatable parameters such as dolly moves, etc.

When **RANGER SOURCE** is selected, move the camera/**BASE** until you are reading your desired target. Reference the **DISTANCE READOUT**. When you are happy with the distance reading, press the desired **MARK DISTANCE TOUCH FIELD** to collect your **MARK**.

Note: The **RANGER SOURCE** can be used to collect distances up to 40' (12.2m).

BUG SOURCE is useful if the focus puller wants to remain by the camera or at his/her focus monitor while collecting marks. In this case a second party such as a camera assistant or stand-in can move an active **BUG** to desired target positions.

When **BUG SOURCE** is selected, move the selected **BUG** to the target position you want as a **MARK**. Reference the **DISTANCE READOUT** during this procedure. When you are happy with the distance reading, press the desired **MARK DISTANCE TOUCH FIELD** to collect your **MARK**.

Note: The **BUG SOURCE** can be used to collect distances of up to 120' (36.5m) in **LONG RANGE MODE** (or 80' (24.4m) if not in **LONG RANGE**).

DISTANCE READOUT / CLEAR ALL MARKS

Displays real-time distance data corresponding to the selected TAPE SOURCE.

Press and hold the DISTANCE READOUT touch area to clear (zero) all stored MARKS.

Note: A reading of “NT” indicates that no valid target was found in the unit’s active distance range.

Note: RANGER MODE SOURCE works to a maximum distance of 40’ (12.2m). While HANDSET TAPE & BUG MODE SOURCES work to a maximum distance of 120’ (36.5m) in LONG RANGE, or a maximum distance of 80’ (24.4m) if not in LONG RANGE.

SYNC MODE ALERT



If displayed, warns that the unit is currently in SYNC MODE.

Note: This alert will display in green if there is a good link with another CINE RT SYSTEM in SYNC MODE. If no link is found, it will display in red.

Note: Both “A” and “B” units need to be set to SYNC MODE for the synchronization link to be active. Both systems also need to be set to the same RF channel

Important: Ultrasonic sampling speeds may be reduced in this mode. See SYNC MODE section for details.

LONG RANGE ALERT

LR

If displayed, warns that the unit is currently in LONG RANGE MODE.

Important: Ultrasonic sampling speeds will be reduced in this mode. See SYNC MODE section for details.

MARK IDENTIFIER

Displays the Mark Number for the adjacent MARK TOUCH FIELD.

MARK DISTANCE

Store or clear MARK distance values for up to 8 MARKS. MARKS 1-4 are stored in MARK BANK 1-4, and MARKS 5 - 8 are stored in MARK BANK 5-8.

Press and release a MARK DISTANCE TOUCH FIELD to copy the current active distance (displayed in the DISTANCE READOUT) to that field.

Press and hold a MARK DISTANCE TOUCH FIELD to clear (zero) the distance in that field.

BACK



Return to the LIVE MODE SCREEN that was active before TAPE MODE was selected.

Press this TOUCH KEY (or the POWER BUTTON) to return to LIVE MODE.

MARKS EDITOR



Allows all collected MARKS to be adjusted, re-arranged or deleted.

Press this TOUCH KEY to enter the **MARKS EDITOR**.

TOGGLE MARK BANK



Toggles between MARK BANK 1-4 and MARK BANK 5-8.

Press this TOUCH KEY to view the indicated MARK BANK.

VITALS MENU SCREEN

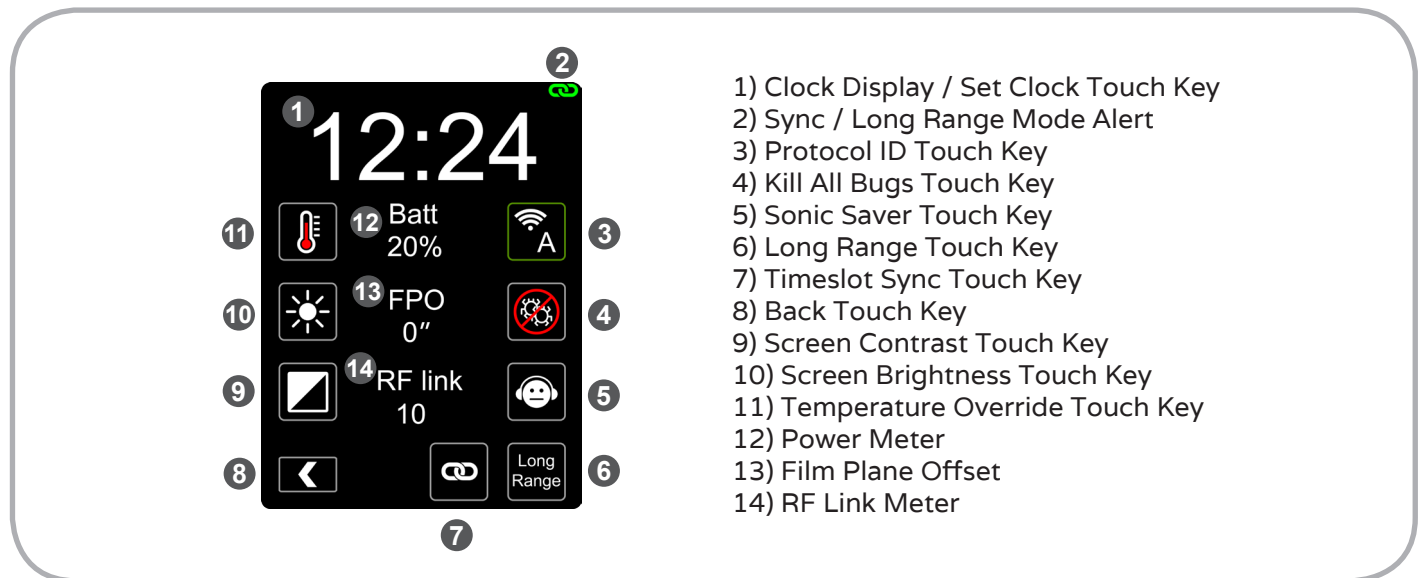

Screen Navigation

Press the TOUCH KEY or corresponding BUTTON to access: CLOCK SET, PROTOCOL ID, KILL ALL BUGS, SONIC SAVER, LONG RANGE, TIMESLOT SYNC, BACK, SCREEN CONTRAST, SCREEN BRIGHTNESS, TEMPERATURE OVERRIDE, FILM PLANE OFFSET.

SYNC / LONG RANGE ALERT, POWER METER & RF LINK METER are display features with no touch functions enabled.

A single press of the POWER BUTTON returns to LIVE MODE from this page

CLOCK DISPLAY / CLOCK SET

Displays the time of day in 24 hour format. Also functions as a hotkey to access the SET CLOCK menu.

Press the Clock Display to access the [SET CLOCK page](#).

SYNC MODE ALERT



If displayed, warns that the unit is currently in SYNC MODE.

Note: This alert will display in green if there is a good link with another CINE RT SYSTEM in SYNC MODE. If no link is found it will display in red.

Note: Both “A” and “B” units need to be set to SYNC MODE for the synchronization link to be active. Both systems also need to be set to the same RF CHANNEL.

Important: Ultrasonic sampling speeds may be reduced in this mode. See SYNC MODE section for details.

LONG RANGE ALERT



If displayed, warns that the unit is currently in LONG RANGE MODE.

Important: Ultrasonic sampling speeds will be reduced in this mode. See SYNC MODE section for details.

HANDSET PROTOCOL ID



Displays the HANDSET’s active PROTOCOL ID and RF STATUS. Also accesses the HANDSET PROTOCOL ID SETTING menu in HANDSET SETTINGS.

Press this TOUCH KEY or corresponding BUTTON to enter the **HANDSET PROTOCOL ID SETTING** page.

Note: This button will display a red border and greyed out RF symbol if there are no RF communications with a BASE set to the same PROTOCOL ID.

KILL ALL BUGS



Sends a POWER DOWN command to ALL active BUGS.

Press this TOUCH KEY to turn off ALL BUGS operating on the active RF CHANNEL.

Note: This TOUCH KEY applies to ALL BUG IDs.

Important: The selected BUGS must be within RF range to respond to the POWER DOWN command.

SONIC SAVER



The CINE RT system incorporates advanced algorithms to ensure an absolute minimum of audio interference. Engaging Sonic Saver reduces the volume level of the BASE ultrasonic signal. For use only in the extremely rare instance that a microphone picks up audio interference from the BASE or BUG(S).

Press the SONIC SAVER TOUCH KEY to engage SONIC SAVER (and see the sound recordist smile for once).

Important: Reduced ping volume will result in reduced effective range of the BASE sensor.

Note: This button will display a green border (and a smiling Sound Person) when Sonic Saver mode is engaged.

LONG RANGE

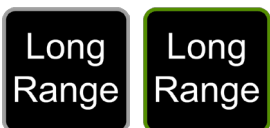

Increases the maximum range of the BUG & HANDSET TAPE sources. Use for measuring

distances exceeding 80' (24.4m) in BUG MODE or when using HANDSET TAPE or BUG SOURCES in TAPE MODE.

Important: Engaging LONG RANGE results in slower ultrasonic sampling rates. This is due to the increased amount of time it takes the ultrasonic ping to travel the extra distance that LONG RANGE accomodates. For maximum unit responsiveness, do NOT use LONG RANGE unless necessary for long distance measurement. See LONG RANGE OPERATION for more details.

Press this TOUCH KEY to toggle LONG RANGE operation. The LONG RANGE ALERT will appear in the top right corner of the screen when LONG RANGE is enabled.

Note: This button will display a green border when LONG RANGE is engaged.

Note: Due to Timeslot Synchronization timing, LONG RANGE cannot be engaged while SYNC MODE is active.

SYNC MODE



Enables two CINE RT SYSTEMS to function cooperatively in close proximity by assigning each system it's own discrete ultrasonic timeslot in order to eliminate crosstalk.

Press the SYNC MODE TOUCH KEY to toggle SYNC MODE. The SYNC MODE ALERT will appear in the upper right corner of the display when SYNC MODE is active. This ALERT will be RED if no second CINE RT SYSTEM is detected or GREEN once synchronization is achieved with a second CINE RT SYSTEM.

Important: For SYNC MODE to work, one CINE RT SYSTEM must have an "A" PROTOCOL ID and the other a "B" PROTOCOL ID and BOTH units must have SYNC MODE engaged and be set to the same RF CHANNEL.

Note: This button will display a green border when SYNC MODE is engaged. The actual synchronization status will be reflected in the colour of the SYNC MODE ALERT icon displayed in the upper right corner of the display.

See SYNC MODE section for more details on Multiple Unit operation

BACK



Return to the LIVE MODE SCREEN that was active before VITALS MENU was selected.
Press this TOUCH KEY (or the POWER BUTTON) to return to LIVE MODE.

SCREEN CONTRAST



Enables the high contrast display setting for use in daylight or bright lighting conditions.
Press this TOUCH KEY to toggle between regular and high contrast display settings.

SCREEN BRIGHTNESS



Controls touchscreen display brightness.
Press this TOUCH KEY to toggle between three levels of screen brightness.

TEMPERATURE OVERRIDE



Accesses the TEMPERATURE OVERRIDE page where temporary adjustments can be made to the BASE's internal thermostat.

The BASE incorporates an thermometer which periodically measures the ambient air temperature and adjusts it's speed of sound calculations accordingly. From a cold start-up, the BASE

takes approximately 5-8 minutes to adjust to the ambient temperature. The TEMPERATURE OVERRIDE allows the BASE thermostat readings to be manually adjusted, enabling instant compensation for sudden temperature shifts or initial startup.

Note: The temperature sensor is the small blue component located directly under the right hand HORN on the BASE (as viewed from the front). Ensure it receives unobstructed airflow for optimal operation.

Press this TOUCH KEY to enter the TEMPERATURE OVERRIDE page.

POWER METER

Displays the HANDSET's approximate remaining battery life in a percentage format. If the HANDSET is connected to internal power, this meter will display the status of the internal battery charge cycle.

Note: Battery usage varies dependant on many factors including display brightness and ambient temperature. The value displayed by this meter factors in many of these variables, but will always be an approximation of the unit's remaining battery life.

FILM PLANE OFFSET (FPO)

Displays the BASE unit's FILM PLANE OFFSET value for quick reference. This value also serves as a hotkey to enter the FILM PLANE OFFSET ADJUST page.

Press the FILM PLANE OFFSET value to enter the FILM PLANE OFFSET ADJUST page.

* see RANGER MODE PAGE for information on how to adjust the FILM PLANE OFFSET.

RF LINK METER

Displays the strength of the RF signal between the HANDSET and BASE units on a scale of 0 to 10.

Note: If the RF link meter consistently displays low values,* increase the RF POWER in SYSTEM RF POWER SETTINGS or decrease the distance between the HANDSET and BASE units. Also ensure that line-of-sight is clear between the HANDSET and BASE at longer ranges.

*Quick fluctuations displaying lower meter values are normal and are no cause for concern.

2X VIEW SCREEN

2X VIEW allows for 2 separate sources to be monitored at the same time. The HANDSET screen will display both sources simultaneously. Active HIGH-BRIGHT devices will display the Source 1 distance if set to SRC 1 and the Source 2 distance if set to SRC 2. (See HIGH-BRIGHT INTERNAL SETTINGS MENU for details).

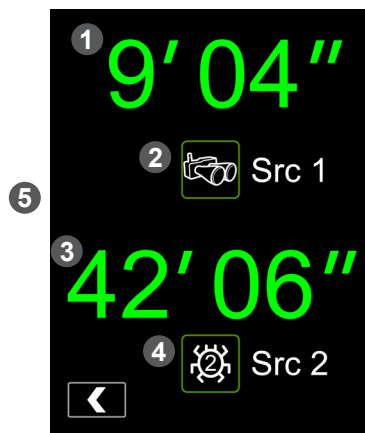

- 1) Source 1 Distance Readout
- 2) Source 1 Indicator/ Selector Touch Key
- 3) Source 2 Distance Readout
- 4) Source 2 Indicator / Selector Touch Key
- 5) Back Touch Key

Screen Navigation

Press the TOUCH KEY or corresponding BUTTON to access: SOURCE 1 SELECTOR, SOURCE 2 SELECTOR, BACK.

SOURCE 1 DISTANCE READOUT and SOURCE 2 DISTANCE READOUT are display features with no touch functions enabled.

A single press of the POWER BUTTON returns to single source LIVE MODE from this page.

SOURCE 1 DISTANCE READOUT

Displays distance data sent by the SOURCE selected as SOURCE 1.

Note: A reading of “NT” indicates that the current SOURCE has No Valid Target (or a BUG source is out of range or not powered).

Note: BUG sources work to a maximum distance of 80' (24.4m) in 2X MODE. The RANGER source works to a maximum distance of 40' (12.2m).

SOURCE 1 INDICATOR / SELECTOR



Toggle between SOURCE 1 sources. Choose RANGER or BUG SOURCES to provide distance information to be displayed in the SOURCE 1 DISTANCE READOUT.

Press to toggle through available SOURCES.

Note: The last active source used before entering the 2X VIEW page will be selected as SOURCE 1.

SOURCE 2 DISTANCE READOUT

Displays distance data sent by the SOURCE selected as SOURCE 2.

Note: A reading of “NT” indicates that the current SOURCE has No Valid Target (or a BUG source is out of range or not powered).

Note: BUG sources work to a maximum distance of 80' (24.4m) in 2X MODE. The RANGER source works to a maximum distance of 40' (12.2m).

SOURCE 2 INDICATOR / SELECTOR



Toggle between SOURCE 2 sources. Choose RANGER or BUG SOURCES to provide distance information to be displayed in the SOURCE 2 DISTANCE READOUT.

Press to toggle through available SOURCES.

BACK



Return to the LIVE MODE SCREEN that was active before VITALS MENU was selected.
Press this TOUCH KEY (or the POWER BUTTON) to return to single source LIVE MODE.

RANGER LIMITS SCREEN

The RANGER LIMITS TOOL allows the CINE RT system to limit its ultrasonic scan to specified minimum and maximum distances while in RANGER MODE. This is an active filter that engages during ultrasonic ping sampling and specifically ignores targets that are outside the NEAR and FAR LIMITS settings.

* see APPENDIX C - LIMITS AND LOCKOUTS, TECHNICAL NOTES for more information.

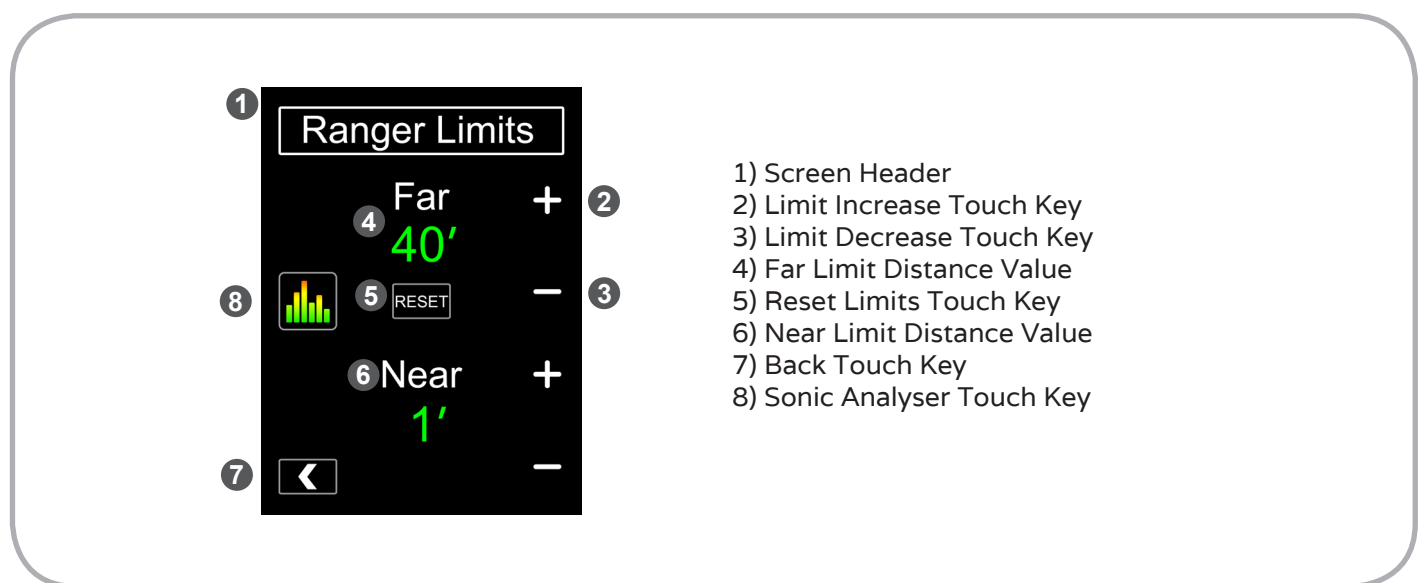

Screen Navigation

Press the TOUCH KEY or corresponding BUTTON to access: LIMIT INCREASE, LIMIT DECREASE, RESET LIMITS, BACK, SONIC ANALYSER.

SCREEN HEADER, FAR LIMIT DISTANCE VALUE & NEAR LIMIT DISTANCE VALUE are display features with no touch functions enabled.

A single press of the POWER BUTTON returns to LIVE MODE from this page.

FAR / NEAR LIMIT DISTANCE VALUES

These values represent the current active limits for RANGER distance readings. The unit will not register any target further than the FAR limit, nor any target closer than the NEAR limit while in RANGER MODE.

Note: If no valid target is found by the RANGER within the active LIMITS range, the DISTANCE DISPLAY will display “NT” (No Target).

LIMIT INCREASE / DECREASE

Used to set the NEAR and FAR RANGER LIMIT DISTANCES.

Press the LIMIT INCREASE / DECREASE touch keys adjacent to the desired limit setting to adjust it's value.

RESET LIMITS



Resets the NEAR and FAR RANGER LIMITS to their default (inactive) values.

Press the RESET LIMITS TOUCH KEY to restore both the NEAR and FAR limits to their minimum and maximum values respectively.

Note: The default RANGER LIMITS are not user programmable and represent the absolute minimum and maximum limits of the RANGER.

BACK



Return to the RANGER MODE LIVE SCREEN.

Press this TOUCH KEY (or the POWER BUTTON) to return to **RANGER MODE**.

SONIC ANALYZER



To assist in finding and ignoring undesirable ultrasonic reflections, enter SONIC ANALYZER to see an active graphic representation of the RANGER signal.

Press this TOUCH KEY to enter the **SONIC ANALYZER**.

RANGER LOCKOUT SCREEN

The RANGER LOCKOUT TOOL allows the CINE RT system to limit it's ultrasonic scan to ignore targets within a specified LOCKOUT zone while in RANGER MODE. This is an active filter that engages during ultrasonic ping sampling and specifically ignores targets that are between the NEAR and FAR LOCKOUT distance settings. Valid targets closer than the NEAR LOCKOUT value and/or further than the FAR LOCKOUT value will register as normal.

* see APPENDIX C - LIMITS AND LOCKOUTS, TECHNICAL NOTES for more information.

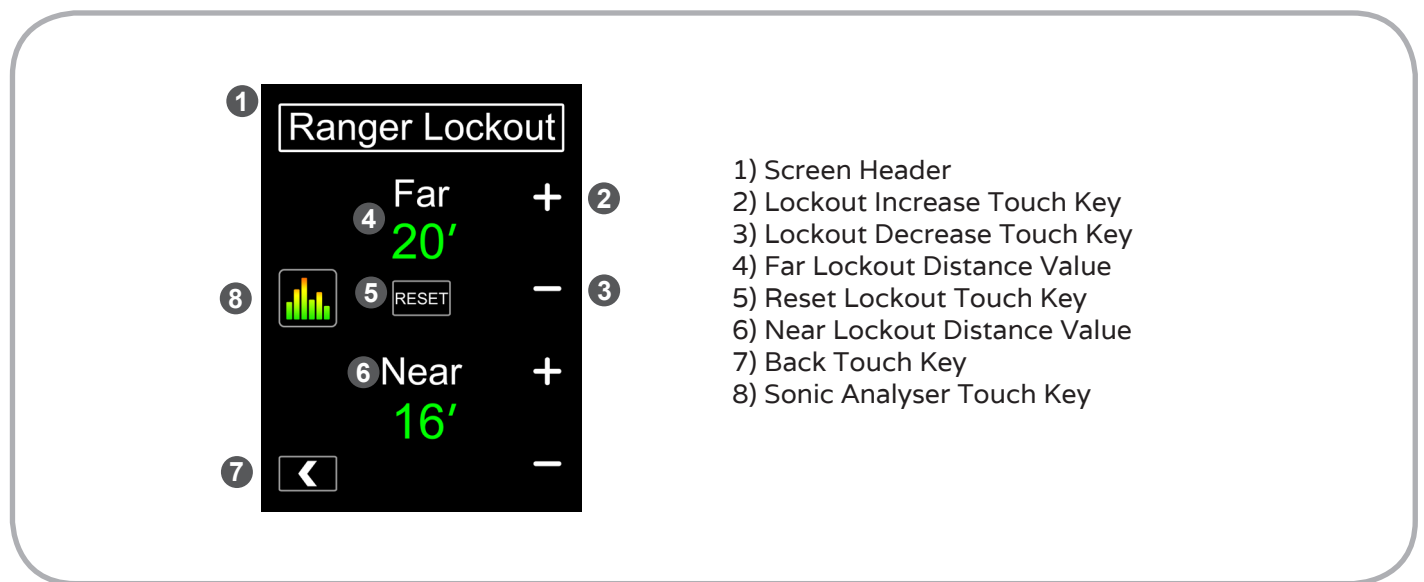

Screen Navigation

Press the TOUCH KEY or corresponding BUTTON to access: LOCKOUT INCREASE, LOCKOUT DECREASE, RESET LOCKOUT, BACK, SONIC ANALYSER.

SCREEN HEADER, FAR LOCKOUT DISTANCE VALUE & NEAR LOCKOUT DISTANCE VALUE are display features with no touch functions enabled.

A single press of the POWER BUTTON returns to LIVE MODE from this page.

FAR / NEAR LOCKOUT DISTANCE VALUES

These values represent the current active lockout boundaries for RANGER distance readings. The unit will not register any target that lies between the NEAR and FAR lockout values while in RANGER MODE.

Note: The LOCKOUT feature is disabled when both NEAR and FAR LOCKOUT DISTANCE VALUES are set to ZERO.

LOCKOUT INCREASE / DECREASE

Used to set the NEAR and FAR RANGER LOCKOUT DISTANCES.

Press the LOCKOUT INCREASE / DECREASE touch keys adjacent to the desired lockout setting to adjust it's value.

RESET LOCKOUT



Clears the NEAR and FAR RANGER LOCKOUT to their inactive (zero) values.

Press the RESET LOCKOUT TOUCH KEY to clear the LOCKOUT values and disable the LOCKOUT TOOL.

Note: The LOCKOUT feature is disabled when both NEAR and FAR LOCKOUT DISTANCE VALUES are set to ZERO.

BACK



Return to the RANGER MODE LIVE SCREEN.

Press this TOUCH KEY (or the POWER BUTTON) to return to RANGER MODE.

SONIC ANALYZER



To assist in finding and ignoring undesirable ultrasonic reflections, enter SONIC ANALYZER to see an active graphic representation of the RANGER signal.

Press this TOUCH KEY to enter the **SONIC ANALYZER**.

SONIC ANALYSER SCREEN

The SONIC ANALYSER aids in identifying specific unwanted ultrasonic reflections while in RANGER MODE. It provides a real-time graphical overview of the ultrasonic signal in relation to the physical working space. It also provides a colour coded overlay of current LIMIT and LOCKOUT values allowing the user to easily see which reflections are currently being ignored by the CINE RT SYSTEM.

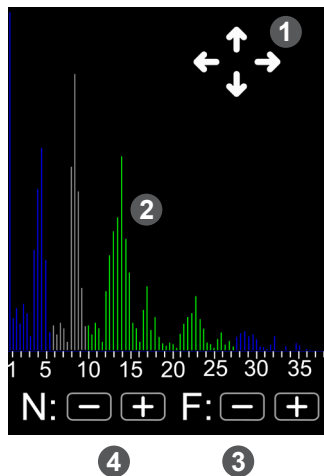

- 1) Zoom / Scale Controls
- 2) Ping Strength Display
- 3) Far Limit / Lockout Adjust Controls
- 4) Near Limit / Lockout Adjust Controls

Screen Navigation

Press the TOUCH KEYS to access: ZOOM / SCALE CONTROLS, FAR LIMIT / LOCKOUT ADJUST CONTROLS, NEAR LIMIT / LOCKOUT ADJUST CONTROLS.

PING STRENGTH VISUAL DISPLAY is a display feature. It also serves as a BACK hotkey to the previous LIMIT or LOCKOUT screen.

A single press of the POWER BUTTON returns to the previous LIMIT or LOCKOUT screen.

ZOOM / SCALE CONTROLS

Use the arrow TOUCH KEYS to adjust the SONIC ANALYSER display's zoom and scale.

Press the UP ARROW to increase the vertical scale of the PING STRENGTH DISPLAY.

Press the DOWN ARROW to decrease the vertical scale of the PING STRENGTH DISPLAY.
Press the RIGHT ARROW to increase the horizontal scale of the PING STRENGTH DISPLAY.
Press the LEFT ARROW to decrease the horizontal scale of the PING STRENGTH DISPLAY.

PING STRENGTH DISPLAY

The SONIC ANALYSER provides a real-time display of the ultrasonic signal strength spectrum as it returns to the BASE. This display shows the strength of the reflected signal across the range of operating distances of the unit. This signal strength is represented by vertical lines that range from shorter (low strength) to taller (high strength reflection). The stronger the reflection (ie: the taller the line), the more likely it is to trigger a distance reading “hit”.

The strength display also incorporates a colour-coding scheme to view the current RANGER LIMITS and LOCKOUT values. The display lines will be shown in GREEN for “active” distances that fall inside the LIMIT values and are NOT locked out. BLUE lines represent distances that fall outside the current active LIMITS. GREY lines represent distances that are currently “locked out” by the LOCKOUT settings. This colour-coding can be used to target LIMIT and LOCKOUT settings to block specific reflections.

Note: The PING STRENGTH DISPLAY portion of the screen also serves as a BACK button hotkey that will return to the previous screen.

FAR LIMIT / LOCKOUT ADJUST CONTROLS

The PLUS and MINUS TOUCH KEYS to the right of the “F:” are used to adjust the FAR LIMIT or LOCKOUT values in real time. They will adjust whichever setting the SONIC ANALYSER SCREEN was entered from. I.e: if the previous screen was the LIMITS screen, the adjustments will be made to the FAR LIMIT value. If the previous screen was the LOCKOUT screen, the adjustments will be made to the FAR LOCKOUT value.

Press the PLUS TOUCH KEY to increase the FAR LIMIT / LOCKOUT value.

Press the MINUS TOUCH KEY to decrease the FAR LIMIT / LOCKOUT value.

Note: All changes made on this screen are applied immediately and will be reflected in the LIMIT / LOCKOUT screens.

NEAR LIMIT / LOCKOUT ADJUST CONTROLS

The PLUS and MINUS TOUCH KEYS to the right of the “N:” are used to adjust the NEAR LIMIT or LOCKOUT values in real time. They will adjust whichever setting the SONIC ANALYSER SCREEN was entered from. I.e: if the previous screen was the LIMITS screen, the adjustments will be made to the NEAR LIMIT value. If the previous screen was the LOCKOUT screen, the adjustments will be made to the NEAR LOCKOUT value.

Press the PLUS TOUCH KEY to increase the NEAR LIMIT / LOCKOUT value.

Press the MINUS TOUCH KEY to decrease the NEAR LIMIT / LOCKOUT value.

Note: All changes made on this screen are applied immediately and will be reflected in the **LIMIT / LOCKOUT screens**.

FOCUS WHISPER SCREEN

The FOCUS WHISPER tool enables you to listen to the MARKS you have collected in TAPE MODE in realtime via an EARBUD as the target moves over them. Various target speed and movement presets are available to optimize how the MARKS are called.

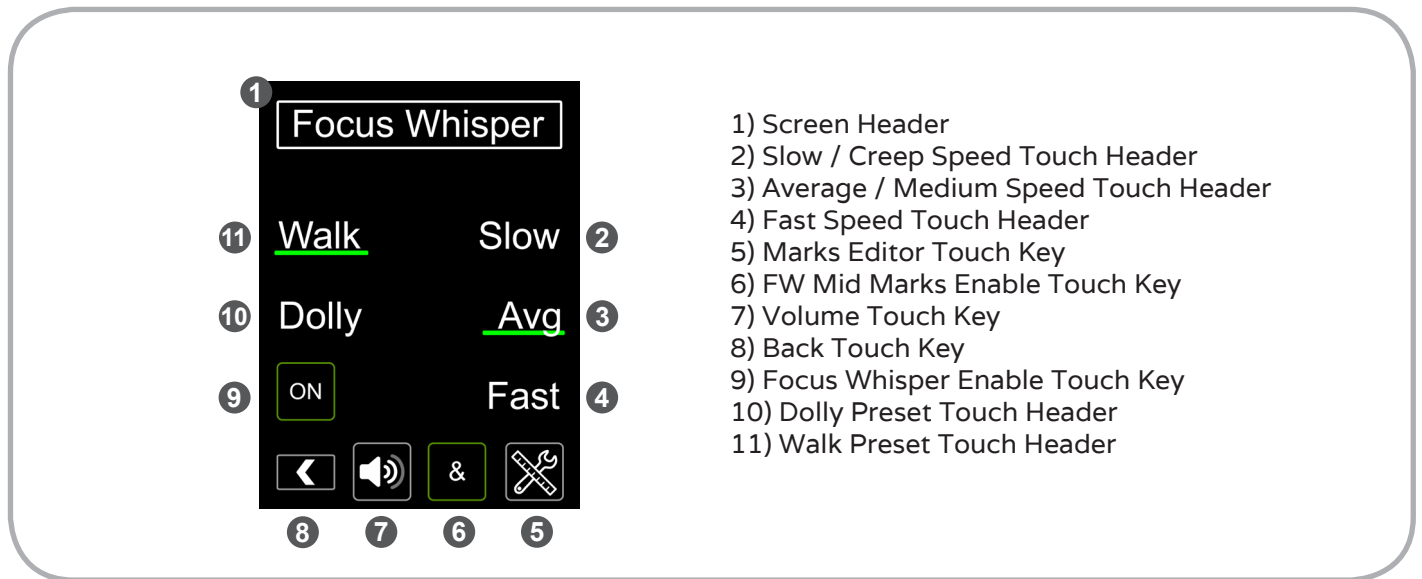

Screen Navigation

Press the TOUCH KEY or corresponding BUTTON to access: SLOW / CREEP SPEED, AVERAGE / MEDIUM SPEED, FAST SPEED BUTTON, MARKS EDITOR, MID MARKS ENABLE TOUCH KEY, VOLUME, BACK, FOCUS WHISPER ENABLE, DOLLY PRESET, WALK PRESET.

SCREEN HEADER is a display feature with no touch functions enabled.

A single press of the POWER BUTTON returns to LIVE MODE from this page.

MOVEMENT PRESETS

The WALK and DOLLY PRESETS enable FOCUS WHISPER to react to human movement and dolly movement CINE RT distance data respectively. Selecting WALK or DOLLY effectively creates a predictive “bubble” around your active MARKS that enables the FOCUS WHISPER tool to call the marks in an organic manner as your target moves over them. This feature

allows the marks calling functionality to more closely mirror how a human would call marks in various situations.

Press WALK or DOLLY TOUCH HEADER as per your target movement type.

SPEED MODIFIERS

The SPEED MODIFIERS adjust the size of the predictive “bubble” around your active MARKS. The faster the target is moving, the wider the bubble in order to compensate for any lag between when your target hits the mark and the time it takes for FOCUS WHISPER to call it.

Press SLOW, AVERAGE, FAST, CREEP, MEDIUM, FAST TOUCH HEADERS as per your target movement type and speed.

MARKS EDITOR



Allows all collected MARKS to be adjusted, re-arranged or deleted.

Press TOUCH KEY to enter the **MARKS EDITOR**.

FW MID-MARKS ENABLE



When enabled, FW MID MARKS will instruct the FOCUS WHISPER tool to call the word ‘and’ halfway between each collected MARK.

Press to toggle MID-MARKS on/off in FOCUS WHISPER.

The touch key will display a green border if calling MID-MARKS is enabled. Otherwise it will display a red border.

VOLUME



Adjusts FOCUS WHISPER volume output.

Press VOLUME TOUCH KEY to toggle between 4 levels of headphone VOLUME.

Note: A test audio sample will be played through the headphone output at the selected volume on every VOLUME TOUCH KEY press.

BACK



Return to the LIVE MODE SCREEN that was active before FOCUS WHISPER was selected.

Press this TOUCH KEY (or the POWER BUTTON) to return to LIVE MODE.

FOCUS WHISPER ENABLE



Turns the FOCUS WHISPER tool ON / OFF.

Press the ENABLE TOUCH KEY to toggle between ON and OFF.

MARKS EDITOR SCREEN

The MARKS EDITOR allows quick manipulation of existing MARKS or the creation of new MARK values. All changes made on this screen are reflected in any tool that uses stored MARKS (i.e: TAPE MODE, FOCUS WHISPER or MARKS VIEW).

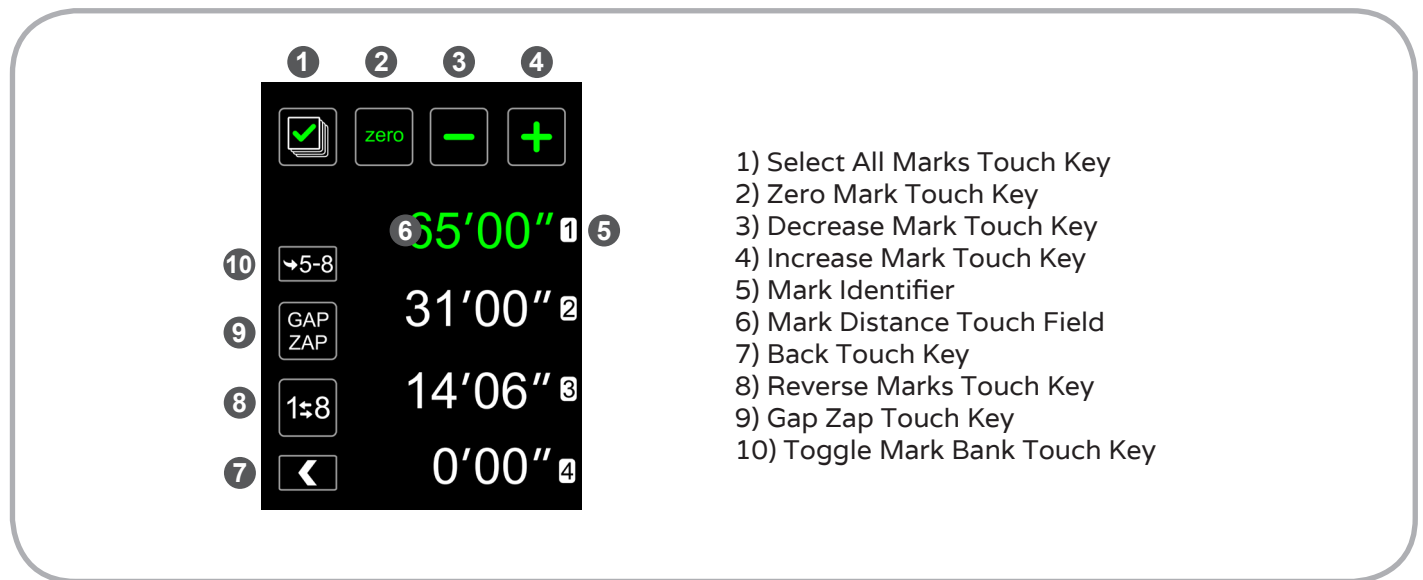

Screen Navigation

Press the TOUCH KEY or corresponding BUTTON to access: SELECT ALL MARKS, ZERO MARK, DECREASE MARK, INCREASE MARK, MARK DISTANCE, BACK, REVERSE MARKS, GAP ZAP, TOGGLE MARK BANK.

MARK IDENTIFIERS are display features with no touch functions enabled.

A single press of the POWER BUTTON returns to LIVE MODE from this page.

SELECT ALL MARKS



Selects all MARKS for editing. Useful for clearing all marks or applying universal offsets to all existing marks.

Press this TOUCH KEY to select ALL 8 user programmable MARKS.

Note: All MARKS will display as GREEN when selected and WHITE when not selected.

Note: This TOUCH KEY selects all MARKS from both MARKS BANKS, currently visible or otherwise.

ZERO MARK(S)



Clears (zeroes) the distance value of all selected MARKS.

Select MARK(S) to clear by pressing the SELECT ALL MARKS TOUCH KEY or the individual MARKS DISTANCE TOUCH FIELDS. Press the ZERO MARK TOUCH KEY to zero all selected MARKS .

Note: If all MARKS are selected with the SELECT ALL MARKS TOUCH KEY, zeroing will clear all 8 user programmable MARKS.

INCREASE / DECREASE MARK(S)

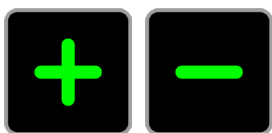

Increases or decreases the distance value of any selected MARK(S).

Select MARK(S) to adjust by pressing the SELECT ALL MARKS TOUCH KEY or the individual MARKS DISTANCE TOUCH FIELDS. Press the INCREASE MARK TOUCH KEY to increase the distance value or the DECREASE MARK TOUCH KEY to decrease the distance value of all selected MARKS .

Important: If more than one MARK is selected, adjustments will only be made to MARKS that have non-zero values. To increase/decrease the value of a zero value MARK, select only that MARK and make adjustments to it.

MARK IDENTIFIER

Displays the Mark Number for the adjacent MARK DISTANCE TOUCH FIELD.

MARK DISTANCE

Displays the stored MARK distance value. Also serves as a TOUCH KEY to select individual MARK values for adjustment.

Press and release a MARK DISTANCE TOUCH FIELD to select that MARK for adjustment.

Press and hold a MARK DISTANCE TOUCH FIELD to quickly create a new distance value via the **QUICK MARK EDITOR**.

BACK



Return to the previous screen.

Press this TOUCH KEY to return to the previous screen

or press the POWER BUTTON to return directly to LIVE MODE.

REVERSE MARKS



Reverses the running order of consecutive MARKS in both MARK BANKS. This is useful when using FOCUS WHISPER or MARKS VIEW to change the order of how or when the MARKS are “called”.

Note: This function will first delete any gaps between MARKS (see GAP ZAP below) and then reverse the order of the consolidated MARKS.

Press this TOUCH KEY to perform the REVERSE MARKS function.

GAP ZAP



Deletes any zero value MARKS from the stored MARKS sets and arranges all collected MARKS consecutively without any breaks. Use this function to quickly readjust marks after clearing one or more MARK values.

Press this TOUCH KEY to perform the “GAP ZAP” function.

TOGGLE MARK BANK



Toggles between MARK BANK 1-4 and MARK BANK 5-8.

Press this TOUCH KEY to view the indicated MARK BANK.

QUICK MARK EDITOR SCREEN

The QUICK MARK EDITOR allows for the rapid creation of new mark values using a convenient numerical touch pad.

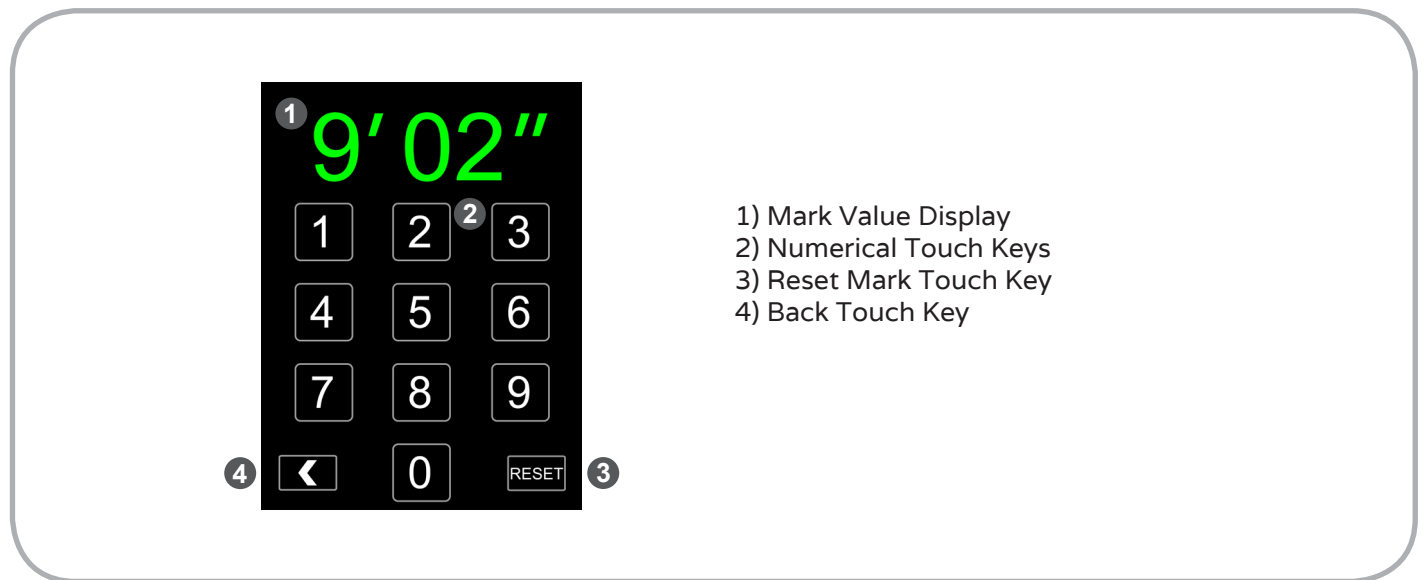

Screen Navigation

Press the TOUCH KEY or corresponding BUTTON to access: NUMERICAL TOUCH KEYS, RESET MARK & BACK.

MARK VALUE DISPLAY is a display features with no touch functions enabled.

A single press of the POWER BUTTON returns to LIVE MODE from this page.

NUMERICAL TOUCH KEYS

Used to enter the new distance value of the MARK.

Press the desired NUMERICAL TOUCH KEY to shift all digits one place to the left and add the selected value as the rightmost digit.

Note: Distances above or below the CINE RT's maximum /minimum distance values will be constrained to those maximum / minimum values upon leaving the QUICK MARK EDITOR.

Note: Distances that have inch units larger than 11" will be converted to standard imperial notation upon leaving the QUICK MARK EDITOR. (for example: a manually entered distance of 10' 20" will be converted to 11' 8")

RESET MARK

Clears the MARK distance value.

Press this TOUCH KEY to reset the MARK value to zero.

BACK



Return to the previous screen.

Press this TOUCH KEY to return to the previous screen.

or press the POWER BUTTON to return directly to LIVE MODE.

SYSTEM SETTINGS MENU TREE

System Settings Submenus are layed out as follows:

SETTINGS:

- CHARGE RATE
- SLEEP TIMERS
- TOUCH SENS (sensitivity)
- SET CLOCK
- MARKS VIEW
- SERIAL OUT

RF:

- HS (Handset) PROTOCOL ID
- HS (Handset) RF CHANNEL
- SYSTEM RF POWER

DSP (Digital Signal Processing):

- DATA SMOOTHING
- OUTLIER REJECTION
- SENSITIVITY

BUG:

- SET BUG RF CHANNEL
- SET BUG ID
- NUMBER OF BUGS
- BUG LED CONTROL
- SHUTDOWN TIMER
- KILL ALL BUGS
- DISPLAY ID

ADVANCED SYSTEM SETTINGS:

- SET UNITS
- RESTORE DEFAULTS
- SET NOISE FLOOR
- CINE-TAP MODE
- CALIBRATE TEMPERATURE
- CALIBRATE ADC
- CALIBRATE RTC

Sample Menu Screen Layout

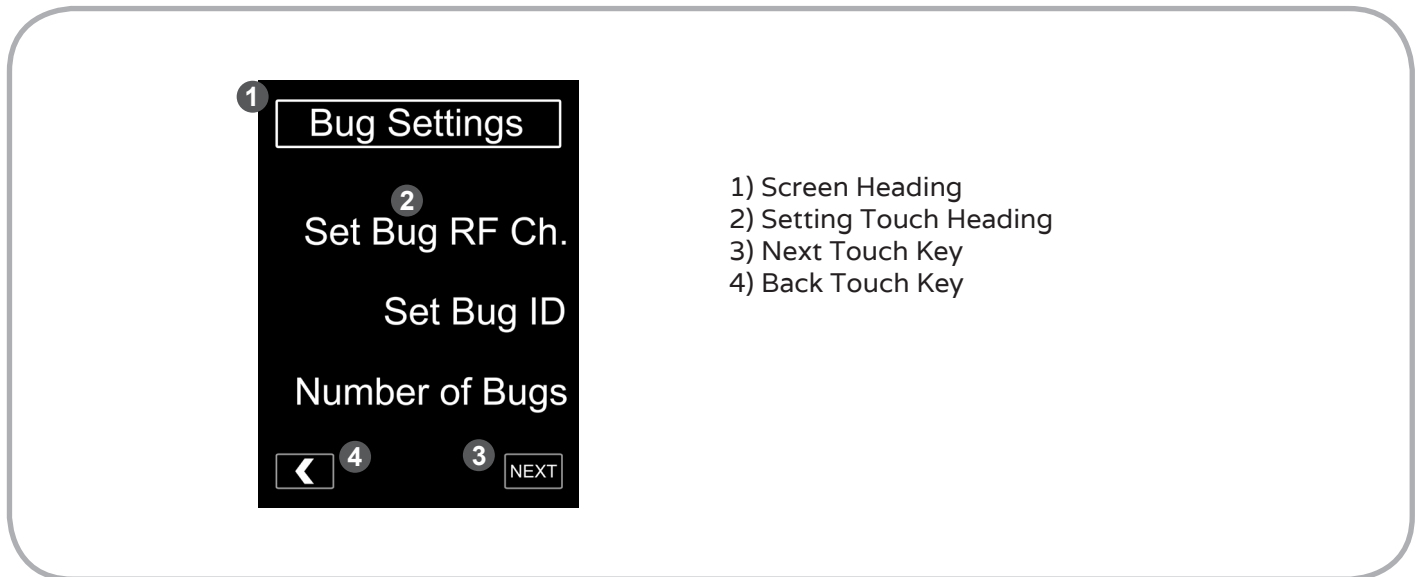

Menu Navigation

Press the SETTING TOUCH HEADINGS or corresponding BUTTONS to access Submenus.

Press the BACK TOUCH KEY to go back one page.

Press the POWER BUTTON to return to the last selected LIVE MODE screen.

Press the NEXT TOUCH KEY (if active) to display further submenu items.

SETTINGS MENU

Menu Navigation

Press the SETTING TOUCH HEADINGS or corresponding BUTTONS to access Submenus.

Press the BACK TOUCH KEY to go back one page.

Press the POWER BUTTON to return to the last selected LIVE MODE screen.

Note: the NEXT TOUCH KEY will display further submenu items.

CHARGE RATE:

Toggles the HANDSET battery charge rate setting when external power is supplied to the unit via the INPUT POWER connector. When FAST CHARGE is set to ON, the unit charges at a rate of 0.5C (approx. 2 hour charge from empty). When FAST CHARGE is set to OFF, the charge rate is reduced to 0.1C (approx. 8-10 hour charge from empty). Under normal conditions, FAST CHARGE can be left to ON. If the unit is operating in high ambient temperatures, lowering the charge rate can reduce heat stress on the battery and internal components while the HANDSET is running.

Note: When the HANDSET is powered down, the charge rate automatically reverts to FAST CHARGE.

SLEEP TIMERS:

Sets the timer values used in putting the HANDSET into a power saving SLEEP MODE. If set, the HANDSET will enter a LOW POWER mode with only the CLOCK showing on the display when it hasn't received any user TOUCH KEY or BUTTON input for the length of time indicated by the timer value. There are separate timer options for each HANDSET power source: BATTERY POWER and EXTERNAL POWER.

Press the white PLUS or MINUS TOUCH ICONS to adjust the timer values (in minutes) up or down. A timer value of 0 (zero) indicates that SLEEP MODE is disabled for that power source.

Note: SLEEP MODE significantly improves overall battery life if the handset is left on but is unused for long periods of time.

TOUCH SENSITIVITY (SENS):

Adjusts the pressure response of the HANDSET touchscreen to the desired sensitivity.

Press the white PLUS or MINUS TOUCH ICONS to adjust the values up or down. A value of 1 is the least responsive to touch pressure, while a value of 10 is the most sensitive.

SET CLOCK:

Sets the internal clock time. The clock is displayed on the VITALS MENU page and during SLEEP MODE.

To set the time in 24 hour format, press the ARROW TOUCH ICON to move the green cursor under the unit to change. Press the white PLUS or MINUS TOUCH ICONS to adjust the values up or down. Push the SET TOUCH KEY to save the new clock time.

Note: Leaving the SET CLOCK screen before pressing the SET TOUCH KEY will cancel the SET CLOCK operation and the internal clock will NOT be saved to the new time.

MARKS VIEW:

The settings in this submenu apply to MARKS VIEW operation. They can also be accessed directly from the MARK VIEW screen by using the SETTINGS TOUCH KEY found there.

FADE BUBBLE: The FADE BUBBLE distance determines the point at either side of a saved MARK that the MARK NUMBER will begin it's fade in or end it's fade out. For example: a MARK set at 5' with a 1' FADE BUBBLE will begin to fade in at 6' and end it's fade out at 4' (assuming a target moving towards camera).

Use the PLUS and MINUS touch keys to increase or decrease the FADE BUBBLE value.

Note: The FADE BUBBLE value cannot be smaller or equal to the MARK BUBBLE value (see below).

FAST TARGET: This touch key enables or disables the FAST TARGET setting in MARKS VIEW. When enabled, MARKS VIEW will override some of the DSP settings to optimize the MARKS VIEW tool for faster moving targets (humans running, cars etc...)

Note: Any DSP changes happen "under the hood" and are only applied when in the MARKS

VIEW page while FAST TARGET is enabled.

MARK BUBBLE: The MARK BUBBLE distance determines the distance around the saved MARKS at which MARKS NUMBERS are displayed at full strength (if FADE is enabled) or in colour (if COLOUR is enabled). For example: With a MARK value of 10', a FADE BUBBLE value of 1' (FADE enabled) and a MARK BUBBLE value of 2" a subject walking towards camera will trigger the following sequence: At 11' the MARK NUMBER will begin to fade in, at 10' 2" the MARK NUMBER will reach full strength (and COLOUR if enabled), until 9' 10" at which point the MARK NUMBER will begin to fade out until completely gone at 9'.

VERTICAL: This TOUCH KEY toggles the MARKS VIEW timeline between vertical (ON) and horizontal (OFF) orientations.

SCROLLING: This TOUCH KEY toggles the SCROLL MODE of the MARKS VIEW screen. When set to ON, the witness mark remains static while the MARKS displayed on the timeline scroll depending on the current TARGET position. When set to OFF, the witness mark moves along the timeline while the MARKS displayed on the timeline remain stationary.

REVERSE: This TOUCH KEY toggles the direction of the the distance scale displayed along the MARKS VIEW timeline. When set to OFF, the distances increase right-to-left in horizontal orientation and bottom-to-top in the vertical orientation. When set to ON, the distances are reversed.

FADE: This TOUCH KEY toggles the fade feature of the MARK NUMBERS. When set to ON the MARK NUMBER will gradually fade in and out as the target approaches the exact mark. The boundaries of this fade are set by the MARK WINDOW value (see above). When set to OFF, the MARK NUMBER will display at full intensity as soon as the target has crossed the MARK boundary (determined by the MARK WINDOW value).

MID MARKS: This TOUCH KEY toggles the display of an "&" symbol halfway between the programmed MARKS distances. This feature is used to help with judging the position of the target between MARKS that are some distance apart.

COLOUR: This TOUCH KEY toggles the colour setting of the MARK NUMBERS. When set to ON the MARK NUMBER will display in green when the exact MARK is triggered. When set to OFF the MARK NUMBER remains white at all times.

TICK VALUE: When set to ON, distance values will be displayed at intervals along the MARKS VIEW timeline ticks.

MARK VALUE: When set to ON, distance values will be displayed with the MARKS indicators set along the MARKS VIEW timeline.

TICKS: This TOUCH KEY toggles the display of distance “ticks” along the timeline. When set to ON, a small tick line will be placed at 5’ intervals in IMPERIAL UNITS or 1m intervals in METRIC UNITS.

SERIAL OUT:

Sets the BASE unit’s SERIAL OUTPUT protocol to interface with third party devices and accessories.

Press the white PLUS or MINUS TOUCH ICONS to toggle between available selections described below:

NONE: Serial output is disabled on the BASE unit.

Classic: “Classic” Ultrasonic device. Mirrors the serial output protocol of older ultrasonic rangefinders. Provides maximum compatibility but slightly slower update speeds.

MDR: Preston Serial Protocol. Used to communicate with a Preston MDR unit to display distance information directly on the Preston Handset.

RF MENU

Menu Navigation

Press the SETTING TOUCH HEADINGS or corresponding BUTTONS to access Submenus.

Press the BACK TOUCH KEY to go back one page.

Press the POWER BUTTON to return to the last selected LIVE MODE screen.

HS (HANDSET) PROTOCOL ID

Sets the PROTOCOL ID setting for the HANDSET. Use to match the HANDSET to a BASE unit working with the same PROTOCOL ID. .

Press the PROTOCOL ID selector TOUCH KEY or corresponding BUTTON to toggle the HANDSET's PROTOCOL ID setting between "A" and "B".

Note: This setting affects ONLY the HANDSET unit. BASE and HIGH-BRIGHT units need to have their PROTOCOL IDs set separately (See [BASE UNIT SET-UP : PROTOCOL ID](#) for details).

HS (HANDSET) RF CHANNEL

Sets the RF CHANNEL for the HANDSET. Use to pair the HANDSET to a BASE unit working on the same radio frequency block. (See [BASE UNIT SET-UP : RF CHANNEL](#) for details).

Press the desired TOUCH KEY to set the HANDSET's RF CHANNEL. The currently selected channel will display with a green border around it's button.

Note: This setting affects ONLY the HANDSET unit. BASE and HIGH-BRIGHT units need to have their RF CHANNEL set separately (See [BASE UNIT SET-UP : RF CHANNEL](#) for details).

SYSTEM RF POWER

Adjusts the RF transmissions strength of the BASE and/or HANDSET to compensate for issues of range or RF interference. If the devices are used in close proximity and RF communications are glitching, the power settings can be lowered to compensate. If maximum range is desired or the ambient RF (2.4GHz) levels are very high, set the RF Power to its maximum (3) on either unit.

Press the white PLUS or MINUS TOUCH ICONS to set the power setting to the desired RF output power: 1 (low), 2 (medium), 3 (high).

If the adjustments are meant to be permanent (i.e: applied on every startup), press the “SAVE DFLT (default)” button. This button will be greyed out if the displayed settings are already saved as the startup defaults.

Note: the factory default setting is “3” and should work in most conditions.

Note: For best bi-directional communications between the BASE and HANDSET, RF power setting levels for the units should match each other.

DSP (DIGITAL SIGNAL PROCESSING) MENU

Menu Navigation

Press the SETTING TOUCH HEADINGS or corresponding BUTTONS to access Submenus.

Press the BACK TOUCH KEY to go back one page.

Press the POWER BUTTON to return to the last selected LIVE MODE screen.

DATA SMOOTHING

Applies a variable length running average to the raw distance measurement data. Higher values increase distance display stability but can decrease the distance display's responsiveness to rapidly changing distance values. A zero (0) value indicates that DATA SMOOTHING is disabled.

Press the white PLUS or MINUS TOUCH ICONS to increase or decrease the DATA SMOOTHING value. Use the distance display to monitor how the different values affect the distance data in real-time. To switch SOURCES for the real-time monitoring, press the SOURCE TOUCH KEY to toggle through available SOURCES.

To save the currently displayed DATA SMOOTHING value as the default (applied automatically at startup) press the "SAVE DFLT" button. This button will be greyed out if the displayed settings are already saved as the startup defaults.

OUTLIER REJECTION

Advanced signal processing option used to ignore momentary readings such as lens crosses or false reflections caught during camera movement. OUTLIER REJECTION can increase distance display stability by using an advanced algorithm that "locks" the distance reading to your target. OUTLIER REJECTION constantly monitors the status of the nearest target to determine if it is a temporary reflection or a desired target. As such, when a new target enters the RANGER field of view, there will be a slight delay (~ 1 second) before the new target's distance reading is displayed. Once the target is acknowledged by the system there are no further delays in the distance readings.

Note: For general use, a setting of 22 ft/s is the recommended default MAX SPEED. For

faster moving targets, increase the MAX SPEED to match the maximum speed of your desired target.

Press the ON/OFF TOUCH KEY to enable or disable OUTLIER REJECTION. If the maximum speed value needs to be adjusted, use the white PLUS and MINUS TOUCH ICONS.

To save the currently displayed OUTLIER REJECTION values as the defaults (applied automatically at startup) press the “SAVE DFLT” button. This button will be greyed out if the displayed settings are already saved as the startup defaults.

SENSITIVITY

Adjusts the trigger threshold for the BASE’s ultrasonic receiver in RANGER MODE. The CINE RT factory default baseline value of 50 (on a scale of 10 - 90) is balanced for general use. Raising the value will allow the BASE to locate smaller targets over greater distance, but may increase false triggers of unwanted targets in the same space. Lowering the value will reduce the instance of false triggers, but may decrease the ability of the BASE to register small targets at greater distance.

Press the PLUS or MINUS TOUCH ICONS to adjust the value up or down in order to achieve the desired sensitivity.

Use the real-time distance display to monitor the effects of any changes in SENSITIVITY.

Note: SENSITIVITY adjustments ONLY affect RANGER MODE readings. If your source isn’t set to RANGER, use the SOURCE TOUCH KEY to switch to RANGER.

To save the currently displayed SENSITIVITY value as the default (applied automatically at startup) press the “SAVE DFLT” button. This button will be greyed out if the displayed settings are already saved as the startup defaults.

BUG SETTINGS MENU

Menu Navigation

Press the SETTING TOUCH HEADINGS or corresponding BUTTONS to access Submenus.

Press the BACK TOUCH KEY to go back one page.

Press the POWER BUTTON to return to the last selected LIVE MODE screen.

Note: the NEXT TOUCH KEY will display further submenu items.

SET BUG RF CH (CHANNEL)

Switches all active BUGs within RF range to the selected RF CHANNEL (1 to 3).

Power up ONLY the BUG(S) whose RF CHANNEL is to be set. With the active BUG(S) less than 25' from the BASE, select the desired BUG CHANNEL by pressing the appropriate TOUCH KEY. ALL active bugs in the vicinity will be assigned the corresponding RF CHANNEL and will display an ID DISPLAY SEQUENCE to verify that the RF CHANNEL has been changed (see [BUG ULTRASONIC TRANSMITTER SECTION](#) for details).

Important: This command will be sent to ALL BUG units in RF range, regardless of their current RF CHANNEL or BUG ID settings !! Ensure that the ONLY active BUG(S) in the vicinity are those that are meant to receive the SET BUG RF CHANNEL command!

The KILL ALL BUGS TOUCH KEY is provided on this page to allow for a quick shutdown of all BUGS in the immediate vicinity before repowering and reprogramming the desired BUG units.

Note: The KILL ALL BUGS TOUCH KEY provided on this page will send a power down command to ALL active bugs in RF range regardless of RF CHANNEL or BUG ID. Ensure that only your BUG units are affected by this command.

SET BUG ID

Assigns all active BUGs within RF range (on the same RF CHANNEL) a BUG SOURCE ID number from 1 to 4.

Note: The CINE RT SYSTEM is currently designed to accommodate a maximum of 4 BUGS at

one time.

Power up the BUG(S) whose BUG ID is to be set. With the active BUG(S) less than 25' from the BASE, select the desired BUG ID by pressing the appropriate TOUCH KEY. ALL active bugs in the vicinity will be assigned the corresponding BUG ID and will display an ID DISPLAY SEQUENCE to verify that the BUG ID has been changed (see [BUG ULTRASONIC TRANSMITTER SECTION](#) for details).

Important: This command will be sent to ALL BUG units operating on the current SYSTEM RF CHANNEL! Ensure that the ONLY active BUG(S) in the vicinity are those that are meant to receive the SET BUG ID command!

Note: The KILL ALL BUGS TOUCH KEY provided on this page will send a power down command to ALL active bugs set to the current RF CHANNEL.

BUG LED CONTROL

Turns the BUG LED on/off. This command can be used to disable the LED indicator lights on active BUG units in case they are visible during a take or distracting in any other way.

Press the ON TOUCH KEY to enable the LED indicator lights of ALL BUGS in RF range that are set to the current system RF CHANNEL.

Press the OFF TOUCH KEY to disable the LED indicator lights of ALL BUGS in RF range that are set to the current system RF CHANNEL.

Note: On receiving a BUG LED ON command, any affected BUG units will display their ID DISPLAY SEQUENCE (see [BUG ULTRASONIC TRANSMITTER SECTION](#) for details).

Note: The LED OFF command is NOT permanent. Once the BUG is powered down and re-powered, the LED indicators will revert to active.

SHUTDOWN TIMERS

Sets the length of time (in hours) after which a BUG unit will turn off automatically if it has received NO communications from a BASE unit.

Note: Communications are considered active any time a BUG is on and within RF range of a BASE unit set to the same RF CHANNEL, even if the BUG is NOT being used as a SOURCE for distance measurement.

To set the BUG SHUTDOWN TIMER, select the desired value using the PLUS and MINUS touch keys and press the SET button.

Note: This change will only take effect if the BASE unit is active and a BUG transmitter is in RF range. When the BUG receives the command, it will flash a number of ORANGE led pulses matching the desired value in hours.

Important: ALL BUGS operating on the same RF CHANNEL as the BASE and HANDSET will be affected by this command if they are in working RF range.

DISPLAY ID



Commands all active BUGS operating on the current SYSTEM RF CHANNEL to display their ID DISPLAY SEQUENCE (see [BUG ULTRASONIC TRANSMITTER SECTION](#) for details).

Press the ON TOUCH KEY to send the DISPLAY ID command. All BUGS in range should flash their ID DISPLAY SEQUENCE.

KILL ALL BUGS



Turns OFF all active BUGS operating on the current SYSTEM RF CHANNEL.

Press the KILL ALL BUGS TOUCH KEY to send the KILL ALL BUGS command to all active BUGS within RF range.

ADVANCED SYSTEM SETTINGS MENU



Menu Navigation

Press the SETTING TOUCH HEADINGS or corresponding BUTTONS to access Submenus.

Press the BACK TOUCH KEY to go back one page.

Press the POWER BUTTON to return to the last selected LIVE MODE screen.

Note: the NEXT TOUCH KEY will display further submenu items.

SET UNITS

Make adjustments to the CINE RT system's measurement and display units.

Distance measurement & display units can be set to either IMPERIAL (ft/in) or METRIC (m/cm). Press the TOUCH KEY located under the "Distance" heading to toggle active distance units.

Important: All FILM PLANE OFFSET and BUG OFFSETS will be reset if CINE RT distance units are changed!

Temperature display units can be set to either Fahrenheit (°F) or Celcius (°C). Press the TOUCH KEY located under the "Temperature" heading to toggle active temperature units.

RESTORE DEFAULTS

Restores all settings to factory default values.

Press the RESET TOUCH KEY located under the "Handset" heading to restore HANDSET settings to factory default.

Note: HANDSET will automatically power down after its RESORE DEFAULTS function has been performed.

Press the RESET TOUCH KEY located under the "Base" heading to restore BASE settings to

factory default.

Important: Core calibration values will NOT be reset with this function (see below).

SET NOISE FLOOR

Important: SET NOISE FLOOR is a non-restorable parameter. RESTORE DEFAULTS has NO effect on this setting. Do NOT adjust this value without proper understanding of its function!

The NOISE FLOOR setting is a BASE unit parameter that sets the absolute background noise threshold for RANGER / BUG & HANDSET TAPE ultrasonic readings. The CINE RT system will “listen” for ultrasonic signals that exceed this threshold while running it’s distance finding routines. If the NOISE FLOOR is set too high, sensitivity at long distances might be reduced. If the NOISE FLOOR is set too low, false triggers resulting from background noise might occur.

Although the NOISE FLOOR is calibrated in the factory, in rare cases changing ambient noise conditions might require a modification to its setting. If false triggered distance readings or reduced sensitivity at distance are presenting themselves, follow the “Field Calibration” method below to re-calculate the NOISE FLOOR setting.

Note: a default value of 5 or 6 is recommended in normal operating conditions.

Field Calibration Method

To adjust the NOISE FLOOR in the field, do the following:

Turn off all Active BUGS and ensure that no other ultrasonic rangefinders (CINE RT or otherwise) are operating in the immediate area.

Press the SOURCE SELECT TOUCH KEY to select an unused BUG SOURCE.

Increase the NOISE FLOOR value using the PLUS BUTTON until the measured distance value disappears and stays hidden. At this stage the BUG MODE sensor is detecting NO targets false or otherwise.

Gradually decrease the NOISE FLOOR value using the MINUS BUTTON until distance readings begin to appear. These readings are triggered by background noise and are NOT desirable.

Increase the NOISE FLOOR setting by 1 or 2 or until the background noise distance readings

reliably disappear. NOISE FLOOR setting values closer to the actual background noise level will increase the CINE RT's sensitivity at long distances, while higher values will reject more false triggers, especially in BUG or HANDSET TAPE modes.

CINE-TAP MODE

Turn Classic Rangefinder compatibility MODE on/off.

When engaged, CINE-TAP MODE will ensure better ultrasonic compatibility with other brands of ultrasonic Rangefinders. If you experience ultrasonic crosstalk (false readings etc...) when another non-Cine RT rangefinder is working in close proximity, turn on CINE-TAP MODE to reconfigure the Cine RT rangefinder to listen to and work around the other rangefinder. In this mode, many key functions are disabled, BUG transmitters will not work and refresh rates are diminished to match those of the non-Cine RT rangefinder.

ONLY use this mode when working with another Rangefinder (non-Cine RT) in close proximity where crosstalk is an issue.

Note: If CINE-TAP MODE is enabled, the BASE will display “ \square ” on it's LED display on startup and its internal Settings menu will be disabled. (See the [CINE-TAP MODE](#) section for more details).

CALIBRATE TEMPERATURE

This is an advanced setting that should only be adjusted AFTER contacting FOCUSBUG technical support.

Important: RESTORE DEFAULTS has NO effect on this setting. Do NOT adjust this value without proper understanding of its function.

If the temperature setting of the CINE RT system seems to be consistently different (more than +/- 2 °C) than ambient temperatures, contact tech support for instructions on recalibrating the internal thermostat.

CALIBRATE ADC

This is an advanced setting that should only be adjusted AFTER contacting FOCUSBUG

technical support.

Important: RESTORE DEFAULTS has NO effect on this setting. Do NOT adjust this value without proper understanding of its function.

CALIBRATE RTC

This is an advanced setting that should only be adjusted AFTER contacting FOCUSBUG technical support.

Important: RESTORE DEFAULTS has NO effect on this setting. Do NOT adjust this value without proper understanding of its function.

If the RTC (real time clock) time is drifting excessively away from the actual time, a recalibration of the Real Time Clock can be performed here. Leave the HANDSET on for at least 10 minutes in a room with a “normal” room temperature for your area. Enter the CALIBRATE RTC menu and press the AUTO TOUCH KEY. The unit will take approximately 30 seconds to perform the calibration and will display a calibration status popup when complete.

VI - SYNC MODE & LONG RANGE OPERATION

For SYNC MODE to be functional the following conditions MUST apply:

- 2 Cine RT BASE units must be operational in the same space.
- BOTH Cine RT systems must be set to the SAME RF CHANNEL.
- One system must be set to PROTOCOL ID 'A', and the other to PROTOCOL ID 'B'.
- SYNC MODE must be enabled on BOTH units (using the **BASE INTERNAL SETTINGS MENU**, &/or the **HANDSET VITALS SCREEN**).

SYNC MODE TECHNICAL NOTES

The Cine RT UBS-100 system uses high frequency ultrasonic pulses to measure distance. This is done by very precisely measuring the time it takes the pulse to travel through the air (and back again, in the case of RANGER mode).

At 68°F (20°C) the speed of sound in air is approximately 1125' per second (343 m/s). Although this seems quite fast, gathering distance measurements over the relatively long ranges that the Cine RT is capable of (up to 120') can take almost a full tenth of a second. Given the high update rate of the system, one can see how quickly the available sonic "space" can become cluttered with ultrasonic pings and reflections.

When two Cine RT systems are working in the same physical location in SYNC MODE, it is necessary to divide up the available ultrasonic "airspace" to ensure the units work seamlessly together without any chance of crosstalk. Crosstalk occurs when one system hears and reacts to the other system's ultrasonic pulses and usually manifests as false or unstable distance readings. In order to guarantee seamless multi-system functionality in SYNC MODE, each unit (protocol ID "A" unit and/or protocol ID "B" unit) is given a dedicated ultrasonic TIMESLOT where it can send and receive pulses clear of interference. The two systems will then use their ultrasonic functions in an alternating fashion, each constrained to its own TIMESLOT.

While this provides crosstalk free ultrasonic measurements, it does come at the cost of somewhat reduced range for the BUG and HANDSET TAPE modes (80'(24.4m) maximum) and a slightly slower distance measurement update rate. In order to get the best performance from your CINE RT system, be sure to only engage SYNC mode when necessary.

If two CINE RT systems in RANGER MODE are in RF range of each other, but NOT close enough for each other's ultrasonic signals to interfere, it may be possible to use them in the same general location without engaging SYNC mode. However if crosstalk becomes problematic (false or erratic distance readings), the best solution is to switch both units to SYNC MODE (one unit set to PROTOCOL ID "A" & the to PROTOCOL ID "B" and BOTH with SYNC MODE enabled (see VITALS SCREEN). When a BUG transmitter is in active use, the chance of crosstalk increases dramatically and it is recommended that the units be placed into SYNC mode.

2X MODE timeslot operation

The same TIMESLOT mechanism also applies to 2X MODE monitoring with a single CINE RT system. The allocation of a distinct TIMESLOT for each source ensures that the measurements returned are free of crosstalk and/or delayed reflection interference. As with SYNC MODE, the BUG SOURCE range is limited to 80' (24.4m) in 2X MODE. 2X MODE mode can only be engaged if SYNC MODE is inactive as a 2X MODE enabled system is using BOTH available time slots for it's measurements.

Long Range operation

The LONG RANGE feature also adjusts how the available "airspace" is used for ultrasonic measurement. In order to keep the highest possible distance measurement update rates, the maximum BUG / HANDSET TAPE mode ranges are limited to 80' (24.4m) unless LONG RANGE is enabled. Once LONG RANGE is enabled, the ultrasonic TIMESLOT is adjusted to accommodate the extra send/receive time and operation continues as normal with the increased maximum range and a slightly reduced update rate. Because the LONG RANGE TIMESLOT is longer than the standard TIMESLOT, LONG RANGE mode cannot be engaged while either SYNC MODE or 2X MODES are active.

Note: LONG RANGE operation has no effect on RANGER MODE distances. The maximum distance for RANGER MODE is 40' (12.2m) regardless of LONG RANGE selection.

WARNINGS:

Warning messages are used to ensure that unintentional conflict between multiple CINE RT units is avoided:

“! Warning. Protocol ID is already in use !!”

This error indicates that 2 or more units are set to the same RF CHANNEL and the same PROTOCOL ID. This condition will cause communications errors between the various HANDSETS and BASE units and MUST be rectified for proper operation. For two units working in the same space, switch one unit to PROTOCOL ID ‘A’ and the other to PROTOCOL ID ‘B’. To ensure ultrasonic crosstalk free operation, switch both units to SYNC MODE.

Note: If a third CINE RT system is in use on the same location, the “extra” system must change RF CHANNELS to an unused channel and be certain that it’s physical location is separate enough from the other units to avoid ultrasonic crosstalk.

“One or more units is not in Sync Mode. To avoid crosstalk, switch BOTH units to Sync.”

This warning informs all active HANDSETS that although the PROTOCOL IDs have been set as ‘A’ and ‘B’, either one or the other of the units is not in SYNC MODE. To avoid unnecessary user distraction, this warning will appear only ONCE per BASE unit power up. The responsibility to keep track of SYNC MODE functionality between the units is then in the operator’s hands, with no further warnings being issued until one or the other BASE units powers off and on again.

Note: SYNC MODE warnings are based on RF range. This means that 2 units working on nearby sets might trigger SYNC warnings even though they are in “independant” ultrasonic spaces. If the users are confident that no ultrasonic crosstalk will occur, SYNC MODE does not need to be engaged. In this case, at least one of the units must exit SYNC MODE. The units will stay in communications but will make no effort to divide up the ultrasonic TIMESLOTS.

VII - CINE-TAP MODE

The Cine RT system comes with an optional feature to allow increased compatibility with other manufacturers ultrasonic rangefinder systems. This “Cine-Tap” Mode allows the Cine RT to be used in close proximity to other rangefinders with minimal ultrasonic interference.

With CINE-TAP MODE engaged, the Cine RT BASE will periodically listen for the non-Cine RT rangefinder’s pulses and time it’s own ultrasonic send and listen periods accordingly in order to avoid interference.

While this feature provides excellent compatibility with other rangefinders in close quarters, it limits the capabilities of the Cine RT system when engaged.

While CINE-TAP MODE is on, the following Cine RT features are disabled.

- Multi-Unit and SYNC MODE operation.
- BUG ultrasonic transmitter operation.
- LONG RANGE MODE.

These restrictions are a direct by product of the steps necessary to provide compatibility with the non-Cine RT rangefinder.

In order to maximize your Cine RT system functionality, CINE-TAP MODE should only be engaged when absolutely necessary. (i.e: in situations where ultrasonic crosstalk is affecting the distance readings of either the Cine RT system or the non-Cine RT rangefinder.

See the HANDSET: ADVANCED SETTINGS MENU for instructions on how to turn CINE-TAP MODE on and off via the HANDSET.

Note: CINE-TAP MODE can only be set via the HANDSET CONTROL UNIT.

APPENDIX A - INTERNAL SETTINGS QUICK GUIDE

BASE: INTERNAL SETTINGS QUICKCHART

To access the BASE INTERNAL SETTINGS MENU, press and hold one of the BUTTONS while the unit is powered up. Release the BUTTON when the first menu item appears.

The RIGHT BUTTON will toggle between options and the LEFT BUTTON will move to the next menu item. Press and hold the LEFT BUTTON to exit the INTERNAL SETTINGS MENU.

| | |
|---|---|
| PROTOCOL ID: "PR" - set the BASE to PROTOCOL ID 'A' "PB" - set the BASE to PROTOCOL ID 'B' | RF CHANNEL: "L1" - set the BASE to RF CHANNEL 1 "L2" - set the BASE to RF CHANNEL 2 "L3" - set the BASE to RF CHANNEL 3 |
| SYNC MODE: "S0" - SYNC MODE OFF "S1" - SYNC MODE ON | UNITS: "U1" - Imperial Units "U2" - Metric Units |
| EXTERNAL SERIAL OUTPUT: "EP" - Preston Native (MDR 3/4) "EL" - "Classic" Protocol (MDR 2/ ARRI...) | |

BASE: ON-BOARD FUNCTIONS QUICK REFERENCE

During regular operation, on-board functions can be accessed using the LEFT and RIGHT MENU BUTTONS as follows:

- FILM PLANE OFFSET(FPO): use the RIGHT BUTTON to increase the FPO value and the LEFT BUTTON to decrease it.
- SENSITIVITY: Press and hold the LEFT BUTTON until "Sn" appears. Use the RIGHT BUTTON to increase the SENSITIVITY and the LEFT BUTTON to decrease it. After 3 seconds of no user interaction, the display will revert to the FILM PLANE OFFSET value.
- TARGETING LASER: Press and hold the RIGHT BUTTON until "Lr" appears. The TARGETING LASER will now be on. It will turn off automatically after 15 seconds. Any BUTTON press will turn it off instantly.

HIGH-BRIGHT: INTERNAL SETTINGS QUICKCHART

To access the HIGH-BRIGHT INTERNAL SETTINGS MENU, press and hold the **BUTTON** while the unit is powered up. Continue to **HOLD** the **BUTTON** until the first menu item appears, then release. To toggle a menu item setting, press and release the **BUTTON**. To access the next menu item, wait until it is displayed. After all menu items have been displayed, the firmware version will display briefly and normal operations will resume.

| | |
|--|--|
| PROTOCOL ID: "P A" - set the HIGH-BRIGHT to PROTOCOL ID 'A' "P B" - set the HIGH-BRIGHT to PROTOCOL ID 'B' | RF CHANNEL: "Ch 1" - set the HIGH-BRIGHT to RF CHANNEL 1 "Ch 2" - set the HIGH-BRIGHT to RF CHANNEL 2 "Ch 3" - set the HIGH-BRIGHT to RF CHANNEL 3 |
| SOURCE: "Src 1" - set the HIGH-BRIGHT to receive SOURCE 1 "Src 2" - set the HIGH-BRIGHT to receive SOURCE 2 | UNITS: "Un 1" - set the HIGH-BRIGHT units to Imperial "Un 2" - set the HIGH-BRIGHT units to Metric |
| CHARGE RATE: "FL 0" - FAST CHARGE disabled "FL 1" - FAST CHARGE enabled | INVERT (FLIP): "FL 0" - Normal display orientation "FL 1" - Inverted display orientation |

HIGH-BRIGHT: ON-BOARD FUNCTIONS QUICK REFERENCE

During regular operation, on-board functions can be accessed using the **BUTTON** as follows:

- **BRIGHTNESS:** Press and release the **BUTTON** to toggle through available LED BRIGHTNESS settings.
- **BATTERY INDICATOR:** Press and hold the **BUTTON** until one of more DOTS appear on the LED display.

| | |
|----------------|------------------------|
| 4 DOTS | Full battery charge |
| 3 DOTS | approx. 75% charge |
| 2 DOTS | approx. 50% charge |
| 1 DOT | approx 25% charge |
| 1 FLASHING DOT | critically low battery |

- **POWER OFF:** Press and hold the **BUTTON** until "OFF" appears. Release the button and the unit will complete it's shutdown sequence automatically.

BUG STARTUP LED SEQUENCE QUICK REFERENCE

On power up, the BUG transmitter will display the following LED sequence:

| | |
|----------------------------|----------------------------|
| ORANGE LED (1- 3 flashes) | RF CHANNEL (1-3) |
| BLUE LED (1- 4 flashes) | BUG ID (1-4) |
| ORANGE LED (1- 4 flashes) | BATTERY LEVEL* (see below) |

*BATTERY LEVEL (1-4). 1 is low battery and 4 is a fully charged battery. Solid steady ORANGE indicates critically low battery and the BUG will shutdown and needs to be charged before further use.

APPENDIX B - QUICK START GUIDE, BASIC

To quickly set up the Cine RT to function as a basic rangefinder, follow the following steps.

Note: this procedure covers only the most basic functionality. Please read the relevant sections of the manual to explore the advanced functions of the CINE RT system.

STEP ONE - Mount the BASE on the camera using the MOUNTING BLOCKS included with your system kit.

STEP TWO - Power the BASE (9-30V) with the LEMO POWER CABLE included with your system kit. The POWER INPUT is found on the bottom right side of the BASE directly under the SERIAL OUTPUT connector.

STEP THREE - Use the RIGHT and LEFT MENU BUTTONS on the BASE to set the FILM PLANE OFFSET value*. This value should equal the horizontal distance between the back of the BASE unit's case and the camera's film plane. If the BASE is located in front of the camera's film plane, the value should be positive. If the BASE is located behind the camera's film plane, the value should be negative.

STEP FOUR - Power up either the HIGH-BRIGHT LED DISPLAY or the HANDSET CONTROL UNIT.

To power up the HIGH-BRIGHT, press and hold the BUTTON until "ON" is displayed on the display.

To power up the HANDSET, press and hold the POWER BUTTON (top left hand side of the HANDSET) until the unit turns on.

To power down the HIGH-BRIGHT, press and hold the BUTTON until "OFF" is displayed on the display.

To power down the HANDSET, press and hold the POWER BUTTON (top left hand side of the HANDSET) until the unit displays the shutdown screen.

* The factory default FILM PLANE OFFSET units are inches. To change the units to centimetres (cm), please see the appropriate section of the manual.

APPENDIX C - LIMITS AND LOCKOUTS, TECHNICAL NOTES

Unlike many older ultrasonic rangefinder systems, the CINE RT SYSTEM's range selection tools (LIMITS & LOCKOUTS) work in real-time as the ultrasonic readings are sampled, rather than applied "after-the-fact" to the measured distance reading. This allows the system to exclude selected regions and still be able to sample objects beyond the closest target.

However, it is significant to note that the objects located within the ranges excluded by the LIMITS and LOCKOUT features may still influence readings if they are very close to the LIMIT and LOCKOUT boundaries.

The ultrasonic reflection of an object is not an instantaneous peak and contains a "tail" that extends for a certain time after the initial reflection. This effect is especially noticeable for objects close to the rangefinder horns that reflect a large amount of ultrasonic energy back to the unit.

In practical terms, this means that the tail end of an object's reflection may extend out of the ranges excluded by LIMITS and/or LOCKOUTs and cause a triggered reading at this exclusion boundary.

Sample Ultrasonic Wave:

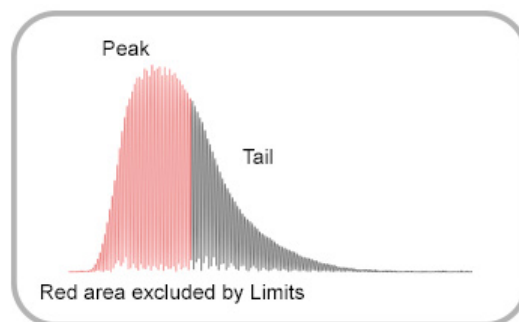

If these boundary reflections are appearing in a real world setting, they can be eliminated by extending the exclusion ranges by a small amount until the boundary reflection readings disappear.

APPENDIX D - MULTIPLE SYSTEMS OPERATION

This appendix aims to clarify how the PROTOCOL ID and RF CHANNEL settings interact when multiple CINE RT systems are used together.

ULTRASOUND vs RADIO COMMUNICATIONS

The two main factors that come into play when using more than one CINE RT system on a location are ULTRASONIC airspace and RADIO FREQUENCY (RF) allocation. The PROTOCOL ID settings are responsible for ULTRASONIC TIMESLOT management, and the RF CHANNEL settings control RF communications between multiple units.

PROTOCOL ID settings:

As described in the SYNC MODE OPERATION section, the use of 2 discrete ULTRASONIC TIMESLOTS ensures that when 2 CINE RT systems are running in the same physical location, there are no erroneous readings resulting from ULTRASONIC crosstalk (where one unit “hears” the ultrasonic pings of the second unit and vice-versa). Because of the time it physically takes for an ultrasonic ping to be sent, hit a target, and return, there is a limit of 2 ULTRASONIC TIMESLOTS in the same “airspace”. Locations separated by distance (over 100’) or by walls or other solid barriers can be considered separate airspaces and need not concern themselves with ULTRASONIC crosstalk. The 2 ULTRASONIC TIMESLOTS are managed by setting the PROTOCOL ID of each system to either “A” or “B”. When the PROTOCOL ID of one unit is set to “A” and the other to “B” (and BOTH units have SYNC MODE engaged), each unit sends ULTRASONIC “pings” only in it’s designated TIMESLOT and ULTRASONIC crosstalk is completely eliminated.

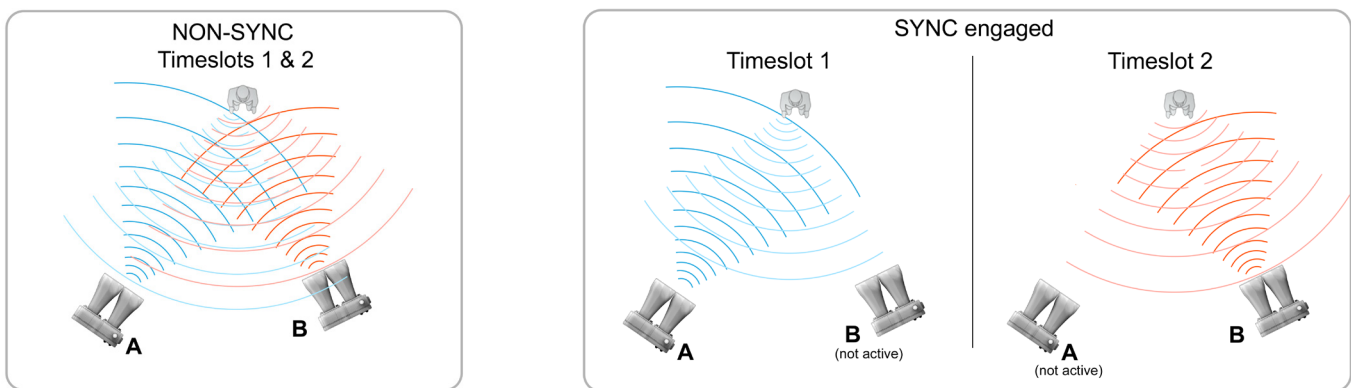

RF CHANNEL settings:

The RF CHANNEL settings are responsible for pairing the RF frequencies of all the components in the CINE RT system. “A” and “B” units working together will share the same RF CHANNEL so that they can communicate and synchronize functions. Select the same RF CHANNEL for all components in the system, including both “A” and “B” units. The BUG transmitters are shared by BOTH “A” and “B” units. An example allocation for a two unit “sync” setup is shown below:

Multi-Unit Setup: “A” and “B” camera in SYNC MODE:

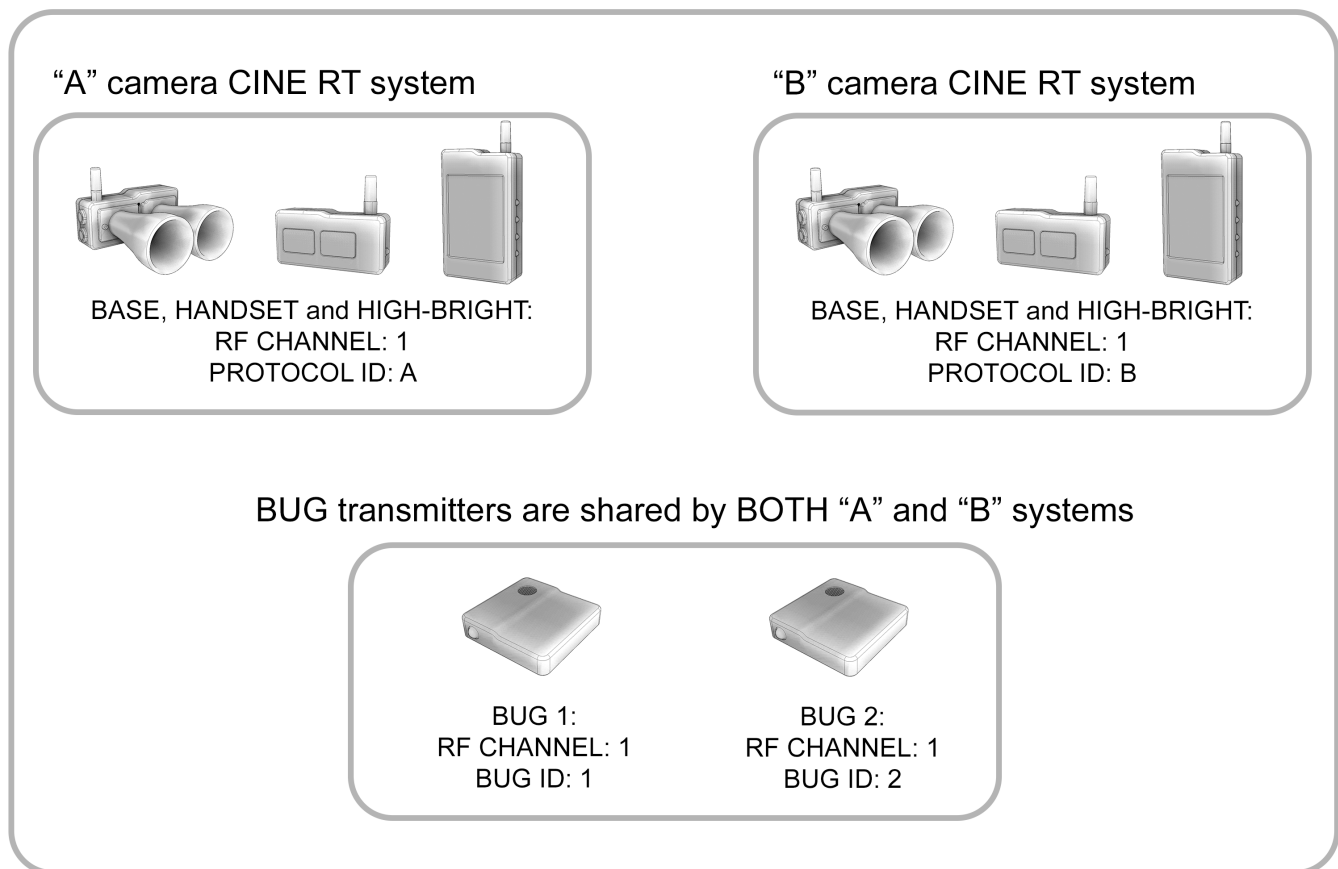

If another production is within RF range (using, for example, RF CHANNEL 1), all components should be set to a different RF CHANNEL (i.e: 2 or 3) to avoid any radio communications interference.

Adding a third CINE RT system to the above setup:

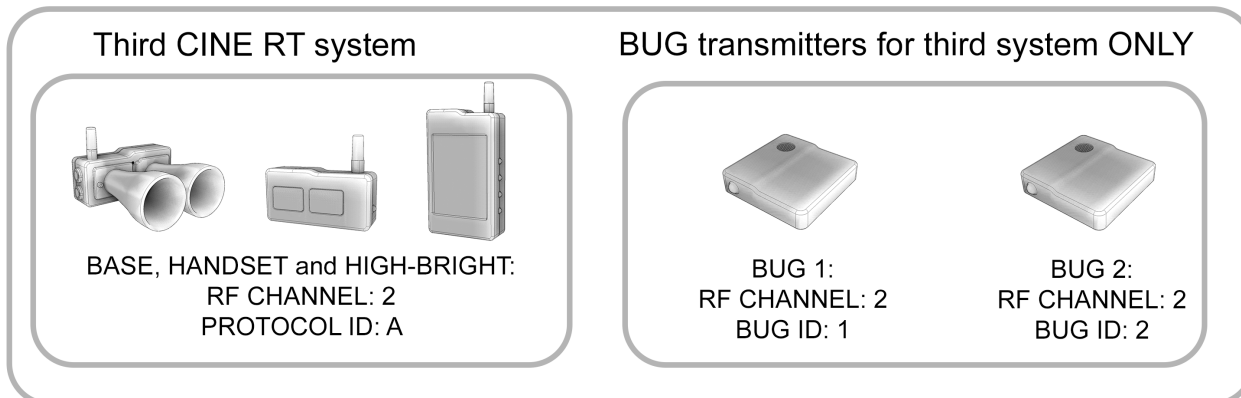

Because only “A” and “B” units are supported on one RF CHANNEL, if a third CINE RT system is in play in the same location, it **MUST** be set to a separate RF CHANNEL to avoid conflicting RF signals between the systems. Care must also be taken to avoid ultrasonic crosstalk in this situation. (see SYNC MODE OPERATION). Due to crosstalk concerns, use of BUG ultrasonic transmitters is not recommended when more than 2 CINE RT systems are in use in the same physical airspace.

FAQs AND TROUBLESHOOTING GUIDE

SETUP:

What Voltage do the units take?

| BASE UNIT | HANDSET CONTROL UNIT | HIGH-BRIGHT DISPLAY | BUG TRANSMITTER |
|-----------|----------------------|---------------------|-----------------|
| 9-30 VDC | 7-20 VDC | 7-20VDC | 5V USB |

Do I need the HANDSET to be on at all times?

- No, the BASE will communicate directly with the HIGH-BRIGHT display even if the HANDSET is off.

Where is the FILM PLANE OFFSET (FPO) measured from?

- The FPO is the distance measured horizontally from the back of the BASE unit's case to the camera's film plane

The BUG shuts down immediately after pressing the POWER BUTTON.

- Ensure the POWER BUTTON on the BUG is held down until AFTER the entire startup LED sequence has flashed (ORANGE / BLUE / ORANGE).

- If the BUG battery is critically low, the ORANGE LED will stay on at the end of the startup LED sequence and the BUG will power down automatically. The BUG must be charged before using it.

COMMUNICATIONS:

The HANDSET displays NO SOURCE (red Source Icon).

- Ensure that the BASE is turned on and that the BASE and HANDSET are set to the same PROTOCOL ID and the same RF CHANNEL.

- Ensure the BASE and HANDSET are in RF range of each other. Maximum RF range is achieved with direct line-of-sight between the units. Walls and other obstacles will reduce the RF range.

The HIGH-BRIGHT unit displays “-rF-”

- Ensure that the BASE is turned on and that the BASE and HIGH-BRIGHT are set to the same PROTOCOL ID and the same RF CHANNEL.
- Ensure the BASE and HIGH-BRIGHT are in RF range of each other. Maximum RF range is achieved with direct line-of-sight between the units. Walls and other obstacles will reduce the RF range.

We're trying to use SYNC MODE but the SYNC INDICATOR is red.

- Ensure that both Cine RT systems' BASE units are turned on.
- Ensure that both Cine RT systems are set to the same RF CHANNEL.
- Ensure that one system's components are set to PROTOCOL ID "A" and the other system's components are set to PROTOCOL ID "B".
- Ensure that BOTH systems have SYNC MODE engaged (status visible on the HANDSET VITALS SCREEN).
- Ensure that the 2 BASE UNITS are within RF range of each other.

The RF LINK meter on the HANDSET VITALS SCREEN flickers between a high value to a low value.

- The RF link meter displays the general health of the RF signal to the HANDSET. Quick incursions to low values (1-4) are expected in normal usage and do not indicate a problem with the RF communications. Consistently low values in the RF link meter indicate a weak RF link and the HANDSET should be moved closer to the BASE or the RF power should be increased on both units.

“! Warning. Protocol ID is already in use !!” warning appears on the HANDSET.

- Ensure that with 2 or more units running that each unit is set to a different PROTOCOL ID / RF CHANNEL COMBINATION. *See SYNC MODE section for details.*

“One or more units is not in Sync Mode. To avoid crosstalk, switch BOTH units to Sync.” warning appears on HANDSET.

- Ensure that both “A” and “B” units have SYNC MODE enabled. *See SYNC MODE section for details.*

DISTANCE READINGS:

The HIGH-BRIGHT / HANDSET is displaying “NT”

- *If there is no valid target in ultrasonic range of the system, a “No Target (NT)” warning will be shown.*
- *Ensure that the LIMITS or LOCKOUTS features aren't excluding the subject.*

The RANGER (rangefinder) feature won't display distances over 40' (12.2m).

- *The maximum distance in RANGER mode is 40' (12.2m) regardless of whether or not LONG RANGE is enabled.*

The BUG / HANDSET TAPE sources won't display distances over 80' (24.4m).

- *The maximum distance in BUG / HANDSET TAPE mode is about 80' (24.4m) if LONG RANGE mode is NOT enabled. Ensure LONG RANGE mode is enabled to gather BUG / HANDSET TAPE distance readings over 80' (24.4m).*

What is the minimum RANGER/BUG distance?

- *The closest target either RANGER or BUG modes can register is 1' (30cm) in front of the BASE unit (measured from the back of the BASE unit case). Different FILM PLANE OFFSET values can cause the minimum reading to vary, but the physical constraint of at least 1' (30cm) from the BASE unit is ALWAYS in effect.*

In BUG mode with no active BUG ,the “NT” reading sometimes flickers to a distance value.

- *If there is no active BUG in ultrasonic range, “NT” will be displayed on the HANDSET / HIGH-BRIGHT. Short high-frequency noises in the environment can sometimes trigger a quick false distance reading in this situation. These readings will not be present if a BUG is sending ultrasonic pulses in range of the BASE.*

LIMITS & LOCKOUTS:

I've set LIMITS to exclude a target, but the distance reading is “hanging” on the LIMIT value.

- *Large obstacles very close to the LIMIT / LOCKOUT cutoff value may cause a continuing ultrasonic*

reflection that triggers a reading at the LIMIT/LOCKOUT cutoff value. Increase the distance between the LIMIT /LOCKOUT cutoff value and the obstacle until the false readings stop. See Appendix C (Limits and Lockouts Technical Notes) for details.

I can't set LIMITS / LOCKOUTS while in BUG mode.

- Because the BUG transmits its ultrasonic pings directly to the BASE, LIMITS and LOCKOUTS are not required for BUG operation. As long as the BUG transducer grille is facing the BASE unit with a clear line-of-sight, false reflections are not possible, eliminating the need for LIMITS and LOCKOUTS.

GENERAL OPERATION:

The distance readings seem to be refreshing slower than normal.

- SYNC MODE and LONG RANGE MODE will both reduce the distance update frequency if engaged. Ensure that neither is ON unless needed.

- Fast moving targets will sometimes exceed the OUTLIER REJECTION maximum speed and cause a slower update frequency. Try turning OUTLIER REJECTION off for fast moving targets or increasing the "MAX SPEED" setting in the OUTLIER REJECTION menu.

- Targets at the long end of the RANGEFINDER range (25'+) may not register a valid hit on every ultrasonic pulse, resulting in a slightly slower update frequency of the target's movement. Try increasing the SENSITIVITY setting to track targets at greater distance.

There is a small delay when a new target appears in RANGER mode.

- OUTLIER REJECTION will "lock" onto an existing target in favour of new targets. If OUTLIER REJECTION is engaged, there will be a small (~1s) delay before the new target is registered if it is some distance from the existing target. Turn OUTLIER REJECTION off to avoid this effect.

How long does it take to charge the internal batteries?

Approximate charge times from empty to 95% charge are as follows:

| | | |
|-------------------------|-----------------|-------------|
| HANDSET CONTROL UNIT | FAST CHARGE ON | ~ 2 hours |
| | FAST CHARGE OFF | ~ 8 hours |
| HIGH-BRIGHT LED DISPLAY | FAST CHARGE ON | ~ 1.5 hours |

Cine RT Operation Guide UBS-100

| | | |
|-------------------------|------------------------|--------------------|
| | <i>FAST CHARGE OFF</i> | <i>~ 6.5 hours</i> |
| <i>BUG MINIATURE TX</i> | | <i>~ 2 hours</i> |

TECHNICAL SPECIFICATIONS

Ultrasonic Base Sensor UBS-100

Dimensions: 9.3 cm x 9.2 cm x 4.0 cm (without antenna)
Weight: 170 grams
Power: 9 - 30V DC
RF: Ultra low power, 2.4 GHz ISM band*
Construction: Milled aluminum and Delrin (horns)
Ultrasonic Frequency: 40kHz
Ultrasonic Sampling Rate: 1 MHz
Rangefinder Range (recommended): 1' - 35' (0.3 - 10.6m)
Connectors: 2 pin LEMO DC power (Arri Standard, Pin 1 = GND, Pin 2 = +VDC)
5 pin LEMO serial

Handset Control Unit HSU-100

Dimensions: 10.5 cm x 6.2 cm x 2.5 cm (without antenna)
Weight: 189 grams
Power: 7 - 20V DC
RF: Ultra low power, 2.4 GHz ISM band*
Construction: Milled aluminum
Ultrasonic Frequency: 40kHz
Handset Tape Range (recommended): 1' - 120' (0.3 - 36.5m)
Connectors: 2 pin LEMO DC power (Arri Standard, Pin 1 = GND, Pin 2 = +VDC)
LCD Display: TFT LCD 3.2"

High-Bright LED Display HBD-100

Dimensions: 7.3 cm x 3.8 cm x 2.4 cm (without antenna)
Weight: 110 grams
Power: 7 - 20V DC
RF: 2.4 GHz ISM band, receive only*.
Construction: Milled aluminum and acrylic (screen)
Connectors: 2 pin LEMO DC power (Arri Standard, Pin 1 = GND, Pin 2 = +VDC)

Bug Miniature Ultrasonic Tx BUG-100

Dimensions: 4.0 cm x 4.0 cm x 1.1 cm
Weight: 19.1 grams
Power: 5V DC (USB)
RF: 2.4 GHz ISM band, receive only.*
Construction: Milled ABS
Ultrasonic Frequency: 40 kHz
Bug Range (recommended): 1' - 120' (0.3 - 36.5m)
Connectors: USB mini B (power)

*Contain FCC ID A7D-24NOD-PA100, IC 10593A-24NOD-PA100. All units comply with the requirements of IC ICES-003, FCC CFR47 Part15/B to Class A Limits.

