

Operator's Manual



McELROY

www.mcelroy.com



TRACSTAR

500 II

series

Automated Fusion Machine

Patent No's. 5,814,182 / 6,212,748 /
6,212,747 / 6,021,832 Other Patents Pending

Manual: T5034902 Revision: 9/06

Original Language: English



**California
Proposition 65 Warning**

*Engine exhaust from this product
contains chemicals known to the State
of California to cause cancer, birth
defects, or other reproductive harm.*



Introduction



Thank You for purchasing this McElroy product

The TracStar® 500 series II model is a self-contained, self-propelled, all terrain fusion machine, and is designed to produce consistently high quality polyolefin pipe butt fusion joints with a minimum of operator effort.

The TracStar® 500 series II model fuses 6" IPS (180mm) minimum to 20" IPS (500mm) maximum pipe.

With reasonable care and maintenance, this machine will give years of satisfactory service.

Before operating this machine, please read this manual thoroughly, and keep a copy with the machine for future reference. This manual is to be considered part of your machine.

Always return the manual to the literature compartment.



PH02299-4-17-02

TX01441-12-29-97

Patent No's. 5,814,182 / 6,212,748 /
6,212,747 / 6,021,832 Other Patents Pending

World Class Training

This manual is intended as a guide only and does not take the place of proper training by qualified instructors. The information in this manual is not all inclusive and can not encompass all possible situations that can be encountered during various operations.

McElroy Manufacturing, Inc., offers advanced training classes to enhance efficiency, productivity, safety and quality. Training is available at our facility or on-site at your location. Call (918) 836-8611.

TX01315-4-7-97



PH00917-8-15-96



TracStar® 500 series II Warranty



LIMITED WARRANTY

McElroy Manufacturing, Inc. (McElroy) warrants all products manufactured, sold and repaired by it to be free from defects in materials and workmanship, its obligation under this warranty being limited to repairing or replacing at its factory and new products, within **3 years** after shipment, with the exception of purchased items (such as electronic devices, pumps, switches, etc.), in which case that manufacturer's warranty applies. Warranty applies when returned freight is prepaid and which, upon examination, shall disclose to have been defective. This warranty does not apply to any product or component which has been repaired or altered by anyone other than McElroy or has become damaged due to misuse, negligence or casualty, or has not been operated or maintained according to McElroy's printed instructions and warnings. This warranty is expressly in lieu of all other warranties expressed or implied. The remedies of the Buyer are the exclusive and sole remedies available and Buyer shall not be entitled to receive any incidental or consequential damages. Buyer waives the benefit of any rule that disclaimer of warranty shall be construed against McElroy and agrees that such disclaimers herein shall be construed liberally in favor of McElroy.

RETURN OF GOODS

Buyer agrees not to return goods for any reason except upon the written consent of McElroy obtained in advance of such return, which consent, if given, shall specify the terms and conditions and charges upon which any such return may be made. Materials returned to McElroy, for warranty work, repair, etc., **must have a Return Material Authorization (RMA) number**, and be so noted on the package at time of shipment. For assistance, inquiry shall be directed to:

McElroy Manufacturing, Inc.
 P.O. Box 580550
 833 North Fulton Street Tulsa, Oklahoma 74158-0550
 PHONE: (918) 836-8611, FAX: (918) 831-9285.
 EMAIL: fusion@McElroy.com

Note: Certain repairs, warranty work, and inquiries may be directed, at McElroy's discretion, to an authorized service center or distributor.

DISCLAIMER OF LIABILITY

McElroy accepts no responsibility of liability for fusion joints. Operation and maintenance of the product is the responsibility of others. We recommend qualified joining procedures be followed when using McElroy fusion equipment.

McElroy makes no other warranty of any kind whatever, express or implied; and all implied warranties of merchantability and fitness for a particular purpose which exceed the aforesaid obligation are hereby disclaimed by McElroy.

PRODUCT IMPROVEMENT

McElroy reserves the right to make any changes in or improvements on its products without incurring any liability or obligation to update or change previously sold machines and/or the accessories thereto.

INFORMATION DISCLOSED

No information of knowledge heretofore or hereafter disclosed to McElroy in the performance of or in connection with the terms hereof, shall be deemed to be confidential or proprietary, unless otherwise expressly agreed to in writing by McElroy and any such information or knowledge shall be free from restrictions, other than a claim for patent infringement, is part of the consideration hereof.

PROPRIETARY RIGHTS

All proprietary rights pertaining to the equipment or the components of the equipment to be delivered by McElroy hereunder, and all patent rights therein, arising prior to, or in the course of, or as a result of the design or fabrication of the said product, are exclusively the property of McElroy.

LAW APPLICABLE

All sales shall be governed by the Uniform Commercial Code of Oklahoma, U.S.A.

Register your product online to activate your warranty:
www.McElroy.com/fusion

(Copy information listed on the machine nameplate here for your records).

Model No. _____

Serial No. _____

Date Received _____

Distributor _____



Table of Contents



Fusion Equipment Safety

Safety Alerts	1-1
Read and Understand	1-1
General Safety	1-2
Wear Safety Equipment	1-2
Fuel Handling	1-2
Units with Engines	1-3
Carbon Monoxide	1-3
Heater is Not Explosion Proof	1-3
Crush Points	1-3
Battery	1-4
Electrical Safety	1-4
Units with Hydraulics	1-5
Facer Blades Are Sharp	1-5
Keep Machine Away From Edge of Ditch	1-5
Positioning Fusion Machine.	1-6
Do Not Attempt to Tow Fusion Machine	1-6
Fusion Procedures	1-6
Heater is Hot.	1-6
Periodically Check Temperature	1-7

Overview

Theory of Heat Fusion	2-1
TracStar® 500 series II Console	2-2
Operator's Fusion Control Pendant	2-2
Control Box.	2-2
Alternate Drive Controls	2-3
Pipe Lift Controls	2-3
Carriage Assembly	2-3
Facer	2-3
Diesel Engine	2-4
Power for Heater	2-4
Oil Reservoir	2-4
Filter.	2-4

COPYRIGHT © 2006
 McELROY MANUFACTURING, INC.
 Tulsa, Oklahoma, USA
 All rights reserved

All product names or trademarks are property of their respective owners. All information, illustrations and specifications in this manual are based on the latest information available at the time of publication. The right is reserved to make changes at any time without notice.



Table of Contents



Operation

Read Before Opening	3-1
Check Oil Level	3-1
Diesel Engine	3-1
Moving Machine Into Position	3-2
Prepare Heater	3-2
Set up Pipe Supports	3-3
Install Clamping Inserts	3-3
Loading Pipe Into Machine	3-3
Fusion Setting and Controls	3-4
Positioning Pipe In Machine	3-4
Facing the Pipe	3-4
Remove Facer	3-5
Position Carriage for Heater Insertion	3-6
Check Heater Temperature	3-6
Select Fusion Pressure	3-7
Inserting Heater	3-7
Heating the Pipe	3-7
Fusing the Pipe	3-8
Opening Movable Jaws	3-8
Opening Fixed Jaws	3-8
Raise Pipe	3-9
Position Pipe for Next Joint	3-9
Install Next Piece of Pipe	3-9

Special Operations - In Ditch

Overview	4-1
Remove the Facer	4-1
Remove Hydraulic Hoses	4-1
Removing Outer Fixed Jaw	4-2
Removing Top Jaws	4-2
Changing Operating Sides	4-2
Changing Carriage Direction Control	4-3
Removing Carriage	4-3
Remove Control Pendant	4-3
Attach Extension Cable	4-3
Attach Linear Transducer Extension Cable	4-4
Lower Carriage into Ditch	4-4
Position Carriage Under Pipe	4-4
Attach Upper Jaws	4-5
Attach Hydraulic Hoses	4-5



Table of Contents



Special Operations - In Ditch (Cont.)

Make Fusion Joint	4-5
Remove Upper Jaws	4-5
Remove Hydraulic Hoses	4-6
Remove Carriage From Ditch	4-6

Special Operations - Lifting the Machine

Heavy Overhead Load	5-1
Crush Points	5-1
Required Equipment	5-1
Attach Slings	5-2
Lifting Safety	5-2

Fusion Control System

TracStar [®] Operator Interface	6-1
Setting up to Fuse Pipe in the Semi-Auto Mode	6-2
Entering Pipe Parameters	6-2

Setting up DataLogger[®] Mode

Setting up to Fuse Pipe in the DataLogger [®] Mode	7-1
---	-----

Setting up Automatic Mode

Setting up to Fuse Pipe in the Automatic Mode	8-1
---	-----

Downloading Joint Reports

Introduction	9-1
System Requirement	9-1
Installing the Program	9-1
Using the Program	9-1
Downloading Joint Reports	9-2
Printing Reports	9-3
Printer	9-3
Setup	9-3
Print Range	9-3
Collate Copies	9-3
Print Quality	9-3
Getting Help	9-4

Maintenance

Preventative Maintenance	10-1
Washing the Machine	10-1
Check Hydraulic Fluid	10-1
Change Hydraulic Fluid and Filter	10-1



Table of Contents



Maintenance (Cont.)

Adjusting System Pressure	10-2
Bleeding Air From Fuel Line	10-2
Engine Oil System	10-3
Facer Blades	10-4
Clean Jaws and Inserts	10-4
Clean Thrust Bearings	10-4
Clean Eyebolt Threads	10-4
Bleeding Air From Hydraulic System	10-5
Installing Butt Fusion Heater Plates	10-5
Clean Heater Surfaces	10-6
Fasteners Must Be Tight	10-6
Engine Maintenance	10-6
Checking Track Tension	10-7
Adjusting Track Tension	10-7
Checking Oil Level in Gearbox	10-8
Changing Oil in Gearbox	10-8

Maintenance Checklist

TracStar® 500 series II	11-1
-----------------------------------	------

Diagnostic Screen

Diagnostic Screen	12-1
-----------------------------	------

Troubleshooting

Engine Will Not Start	13-1
Carriage Will Not Move	13-4
Pendant Check	13-5
Cannot Set or Hold Carriage Pressure	13-6
Diagnostic Screen Pressure Tes	13-7
Control Box Check	13-8
Heater Temp is Not Correct	13-9
Facer Will Not Run	13-10
Lights Do Not Work	13-11
Engine Instruments	13-12
Hydraulic Pressure Calibration Failure	13-13

Hydraulic Fluids

Hydraulic Fluids	14-1
----------------------------	------

Specifications

TracStar® 500 series II Specifications	15-1
--	------



Fusion Equipment Safety



Safety Alerts



This hazard alert sign appears in this manual. When you see this sign, carefully read what it says. YOUR SAFETY IS AT STAKE.

You will see the hazard alert sign with these words: DANGER, WARNING, and CAUTION.



Indicates an imminently hazardous situation which, if not avoided, will result in death or serious injury.



Indicates a potentially hazardous situation which, if not avoided, could result in death or serious injury.



Indicates a hazardous situation which, if not avoided, may result in minor or moderate injury.

In this manual you should look for two other words: **NOTICE** and **IMPORTANT**.

NOTICE: can keep you from doing something that might damage the machine or someone's property. It may also be used to alert against unsafe practices.

IMPORTANT: can help you do a better job or make your job easier in some way.

TX00030-12-1-92



WR00051-11-30-92

Read and Understand

Do not operate this equipment until you have carefully read, and understand the "Safety" and "Operation" sections of this manual, and all other equipment manuals that will be used with it.

Your safety and the safety of others depends upon care and judgment in the operation of this equipment.

Follow all applicable federal, state, local, and industry specific regulations.

McElroy Manufacturing, Inc. cannot anticipate every possible circumstance that might involve a potential hazard. The warnings in this manual and on the machine are therefore not all inclusive. You must satisfy yourself that a procedure, tool, work method, or operating technique is safe for you and others. You should also ensure that the machine will not be damaged or made unsafe by the method of operation or maintenance you choose.



WR00052-12-1-92

TX00031-12-8-92



Fusion Equipment Safety



General Safety

Safety is important. Report anything unusual that you notice during set up or operation.

LISTEN for thumps, bumps, rattles, squeals, air leaks, or unusual sounds.

SMELL odors like burning insulation, hot metal, burning rubber, hot oil, or natural gas.

FEEL any changes in the way the equipment operates.

SEE problems with wiring and cables, hydraulic connections, or other equipment.

REPORT anything you see, feel, smell, or hear that is different from what you expect, or that you think may be unsafe.



SAFE1ST122292

TX001144-22-93

Wear Safety Equipment

Wear a hard hat, safety shoes, safety glasses, and other applicable personal protective equipment.

Remove jewelry and rings, and do not wear loose-fitting clothing or long hair that could catch on controls or moving machinery.

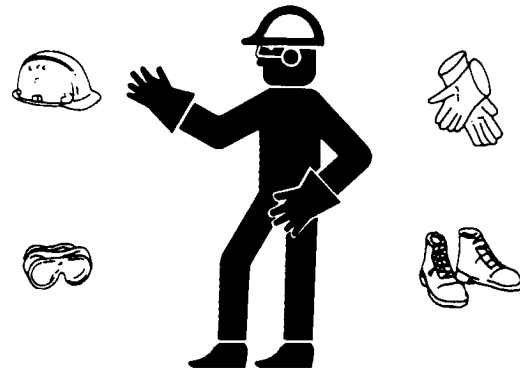

WPR0053-12-2-92

TX00032-4-7-93

Fuel Handling

⚠ DANGER Gasoline and diesel fuel are extremely flammable and their vapors will explode if ignited.

Do not fill the fuel tank while the engine is hot or running, as spilled fuel could ignite.

Refuel in a well ventilated area. Do not smoke or allow flames or sparks in the area where the engine is refueled, or where gasoline is stored.

Do not start the engine near spilled fuel. Wipe up spills immediately.

Make sure the fuel tank cap is closed and properly secured.

Avoid repeated or prolonged contact with skin or breathing of vapor.

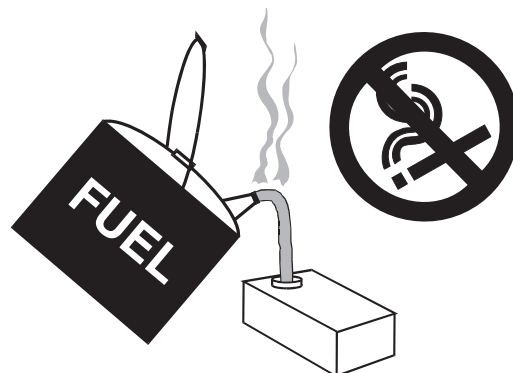

CD003652-19-97

TX00953-2-19-97



Fusion Equipment Safety



Units With Engines



Combustion engines can cause explosions when operated in a hazardous environment. Do not operate gas or diesel powered machines in a hazardous environment.

When operating in a hazardous environment, keep engine and chassis in a safe area by using hydraulic extension hoses.

Help prevent fires by keeping machine clean of accumulated trash, debris and facer shavings.

TX01266-2-21-97



WR000804-1-2-93

Carbon Monoxide



Engine exhaust gases contain poisonous carbon monoxide. Carbon monoxide can cause severe nausea, fainting and death. Avoid inhaling exhaust fumes and never run the engine in a closed or confined area.

TX00954-5-14-96

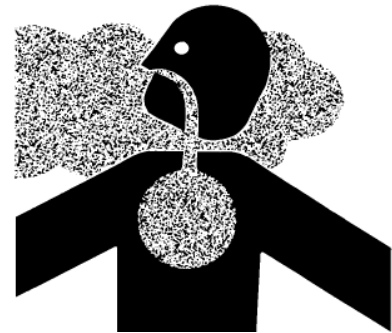

WR00093-5-14-96

Heater is Not Explosion Proof



This heater is not explosion proof. Operation of heater in a hazardous environment without necessary safety precautions will result in explosion and death.

When operating in a hazardous environment, the heater should be brought up to temperature in a safe environment, then **unplugged before entering** the hazardous atmosphere for fusion.

TX00100-9-16-94



WR00034-11-30-92

Crush Points



Hydraulically operated jaws are operated under pressure. Anything caught in the jaws will be crushed. Keep fingers, feet, arms, legs, and head out of the jaw area. Always check pipe alignment with a pencil or similar object.

TX00103-4-6-93



WR00012-12-4-92



Fusion Equipment Safety



Battery

⚠️ WARNING

Do not expose the battery to flames or electrical sparks. Hydrogen gas generated by battery action is explosive. Blindness or serious injury can result from an exploding battery.



CD001769-14-95

⚠️ WARNING

Do not allow battery fluid to contact your skin, eyes, fabrics, or painted surfaces. Sulfuric acid can cause burns. After touching a battery or battery cap, do not touch or rub your eyes.

Thoroughly wash your hands. If the acid contacts your eyes, skin or clothing, immediately flush with water for at least 15 minutes and seek medical attention.



CD001779-14-95

TX00650-9-14-95

Electrical Safety

⚠️ WARNING

Always ensure power cords are properly grounded. It is important to remember that you are working in a wet environment with electrical devices. Proper ground connections help to minimize the chances of an electric shock.

Frequently inspect electrical cords and unit for damage. Have damaged components replaced and service performed by a qualified electrician.

Do not carry electrical devices by the cord.

NOTICE: Always connect units to the proper power source as listed on the unit, or in the owner's manual. On units with two power cords, plug each cord into separate power circuits. Do not plug into both outlets of one duplex receptacle.

NOTICE: Disconnect the machine from the power source before attempting any maintenance or adjustment.



WR00055-4-7-93



WR00025-11-30-92

TX00105-4-12-93



Fusion Equipment Safety



Units With Hydraulics

Although the hydraulic pressures in this machine are low compared to some hydraulically operated equipment, it is important to remember that a sudden hydraulic oil leak can cause serious injury, or even be fatal if the pressure is high enough.

⚠ WARNING Escaping fluid under pressure can penetrate the skin causing serious injury. Keep hands and body away from pinholes which eject fluid under pressure. Use a piece of cardboard or paper to search for leaks. If any fluid is injected into the skin, it must be immediately removed by a doctor familiar with this type of injury.

NOTICE: Wear safety glasses, and keep face clear of area when bleeding air from hydraulic system to avoid spraying oil into eyes.



WR00078-4-8-93

TX00110-8-23-95

Facer Blades Are Sharp

⚠ WARNING Facer blades are sharp and can cut. Never attempt to remove shavings while the facer is running, or is in the facing position between the jaws. Use care when operating the facer, and when handling the unit.

NOTICE: Disconnect power from the facer, and remove the facer blades before attempting any maintenance or adjustment.

NOTICE: Never extend the blade beyond the inner or outer circumference of the facer.

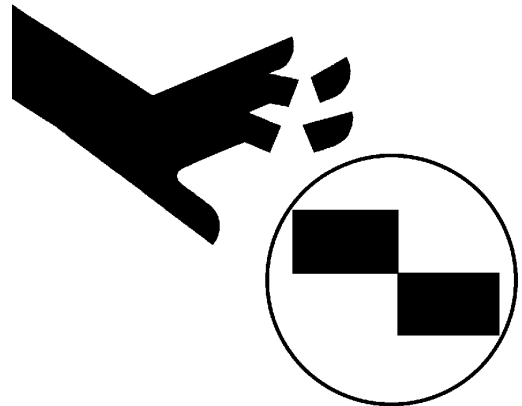

WR00073-4-6-93

TX02378-1-24-05

Keep Machine Away From Edge of Ditch

⚠ WARNING Heavy equipment too close to a ditch can cause the walls of the ditch to cave-in. Keep the machine far enough away from the edge of the ditch to prevent injury to personnel and equipment from a cave-in.

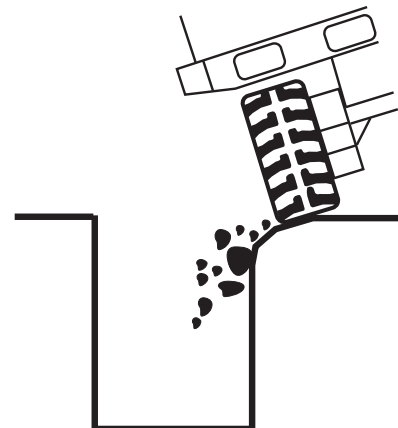

CD000408-12-31-97

TX01447-12-30-97



Fusion Equipment Safety



Positioning Fusion Machine

Place fusion machine on as level ground as possible.

If it is necessary to operate machine on unlevel grade, make sure that the ground is stable. Some unstable conditions may be ice, snow, mud and loose gravel.

WARNING For operation safety, never operate the machine on a grade steeper than 30 %. (A 3 foot elevation change in 10 feet)

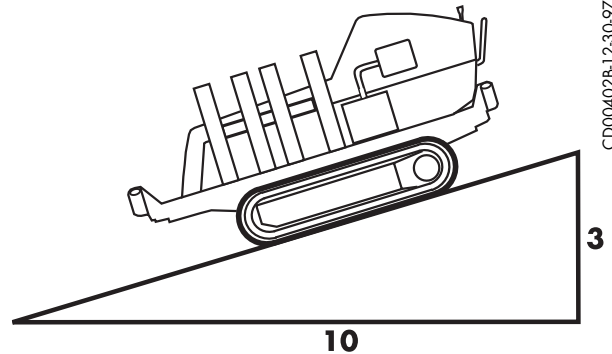

TX01448-12-30-97

Do Not Attempt to Tow Fusion Machine

CAUTION The machine is not designed for towing. The tracks will not move. Attempting to tow the machine can result in machine damage. Always transport the machine by flat bed truck or similar means, and make sure that unit is properly secured.

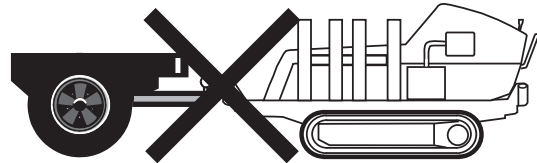

TX01446-12-29-97

Fusion Procedures

Obtain a copy of the pipe manufacturer's procedures for the pipe being fused. Follow the procedure carefully, and adhere to all specified parameters.

CAUTION Failure to follow pipe manufacturer's procedure could result in a bad joint. Always follow pipe manufacturer's procedures.

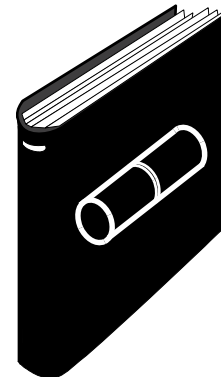

TX00113-4-12-93

Heater Is Hot

CAUTION The heater is hot and will burn clothing and skin. Keep the heater in its insulated heater stand or blanket when not in use, and use care when heating the pipe.

NOTICE: Use only a clean non-synthetic cloth such as a cotton cloth to clean the heater plates.



TX00104-8-12-94



Fusion Equipment Safety



Periodically Check Temperature

NOTICE: Incorrect heating temperature can result in bad fusion joints. Check heater plate surface temperature periodically with a properly calibrated pyrometer, and make necessary adjustments.

The thermometer on heaters indicate internal temperature, and should be used as a reference only.



WR00077B-4-16-93

TX00107-11-13-95

Theory of Heat Fusion

The principle of heat fusion is to heat two surfaces to a designated temperature, and then fuse them together by application of force. This pressure causes flow of the melted materials, which causes mixing and thus fusion. When the polyethylene pipe is heated, the molecular structure is transformed from a crystalline state into an amorphous condition. When fusion pressure is applied, the molecules from each pipe end mix. As the joint cools, the molecules return to their crystalline form, the original interfaces are gone, and the two pipes have become one homogeneous pipe. The joint area becomes stronger than the pipe itself in both tensile and pressure conditions.

The principle operations include:

- Clamping** The pipe pieces held axially to allow all subsequent operations to take place.
- Facing** The pipe ends must be faced to establish clean, parallel mating surfaces perpendicular to the centerline of the pipes.
- Aligning** The pipe ends must be aligned with each other to minimize mismatch or high-low of the pipe walls.
- Heating** A melt pattern that penetrates into the pipe must be formed around both pipe ends.
- Joining** The melt patterns must be joined with a specified force. The force must be constant around the interface area.
- Holding** The molten joint must be held immobile with a specified force until adequately cooled.
- Inspecting** Visually examine the entire circumference of the joint for compliance with standards established by your company, customer, industry, federal, state, or local regulations.

Each pipe manufacturer has a slightly different approach for fulfilling the heating, joining, and holding phases, but the end result is the same – a fusion joint that is as strong or stronger than the pipe itself.

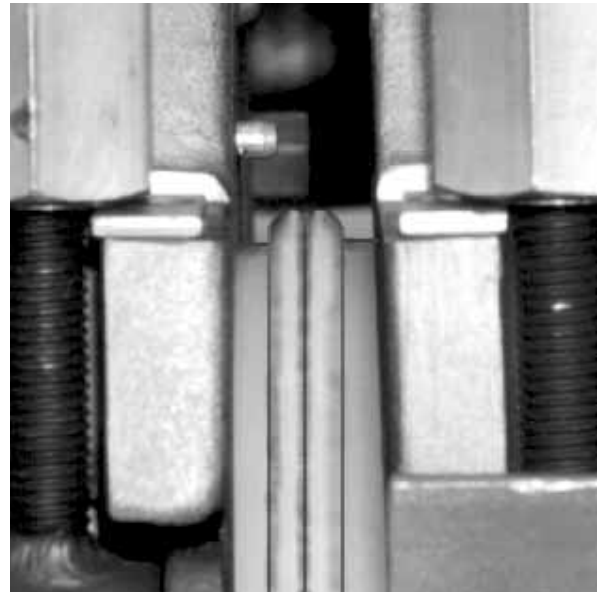

PH00363B-1-4-96



Overview



TracStar® 500 series II Console

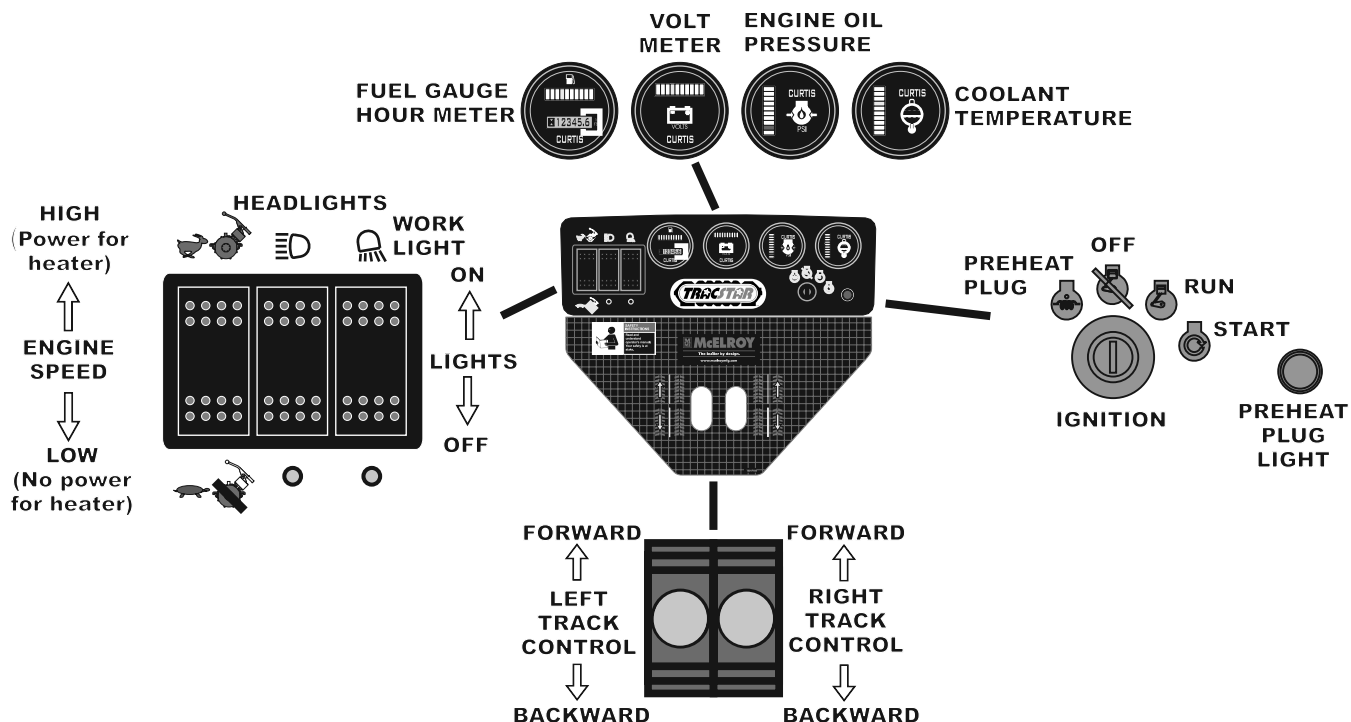

CD00407b-12-31-97

Operator's Fusion Control Pendant

The control pendant is designed to control 5 individual pressure settings. Face, Heat, Soak, Fuse and Cool. Setup for these controls is explained in the "Fusion Control System" section of this manual.

The carriage directional control, a pressure selector control and the facer on/off control is also located on the control pendant.

On top of the control pendant is a red emergency stop button. Push down on the button to shut down the system. The button must be rotated up to resume operations.

TX01453-2-6-98



PH01302-3-4-98

Control Box

The Control Box contains the electronics that operate the system. There are lights on top that indicate the status of the system as well as a fuse box.

There are no servicable parts inside the Control Box.

Refer to the **Troubleshooting** section of this manual for more information.

TX01495-3-3-98



PH01289-3-3-98



Overview



Alternate Drive Controls

Alternate track drive controls are located on the pendant side of the machine. Each lever controls one track. Both levers must be moved together to go forward or backward in a straight line. Moving levers in opposite directions makes the machine turn sharply.

TX01454-2-9-98

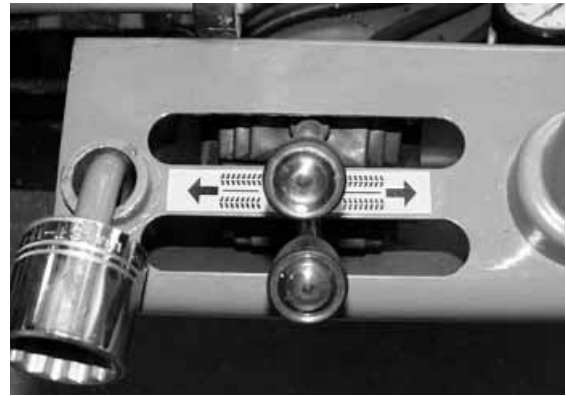

PH01247-1-29-98

Pipe Lift Controls

The pipe lift controls are located under the pendant. Moving the right lever up and down moves the rear pipe lift up and down. Moving the left lever up and down moves the forward pipe lift up and down.

TX01455-2-9-98



PH03297-9-18-06

Carriage Assembly

The carriage assembly consists of two fixed jaws and two hydraulically operated movable jaws. The top jaws may be reversed to open from the other side of the carriage. Simply remove the detent pins from the back of the jaw. Use one of the pins to push the clamp knob eyebolt detent pins out and reverse the pivot and clamping sides of the jaws.

The carriage assembly can be removed from the machine for remote operation. An optional hydraulic extension kit and two extension cables (pendant and linear transducers) are required when using the carriage remotely.

TX02379-1-24-05

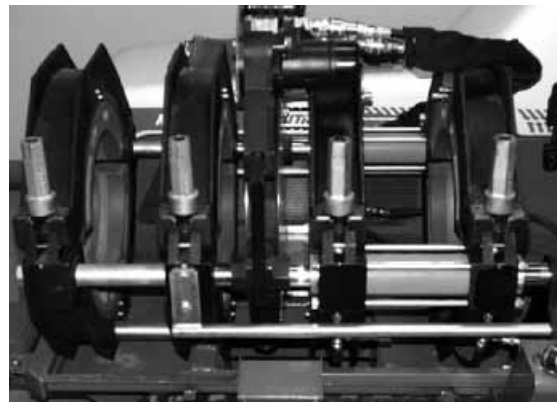

PH01254-1-29-98

Facer

The facer is a McElroy Rotating Planer-Block design. The blade holders each contain three cutter blades. The block rotates on ball bearings and is chain driven (enclosed in lubricant) by a hydraulic motor.

NOTICE: Never extend the blade beyond the inner or outer circumference of the facer.

TX02376-1-10-05



PH01256-2-2-98



Overview



Diesel Engine

Read the operating and maintenance instructions for the engine before operating.

There is a key ignition on the console that shows the preheat, start, run and off positions.

TX01465-2-10-98



PH01261-2-12-98

Power for Heater

The heater cord plugs into a military type receptacle on the frame. Tighten coupling nut after plugging into receptacle.

TX01466-2-10-98



PH01999-1-15-01

Oil Reservoir

The oil reservoir is located under the front hood of the machine. The oil level sight gauge is located on the front of the reservoir. Proper fluid level is indicated on the sight gauge.

TX01467-2-10-98

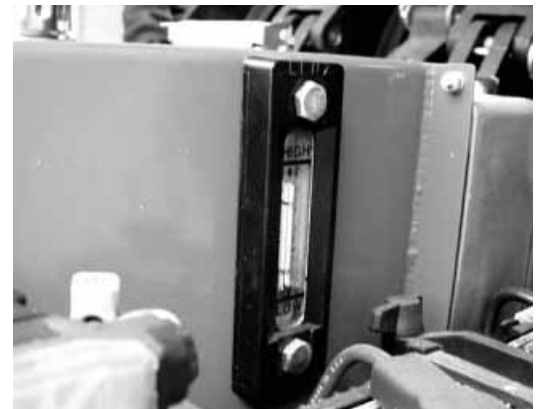

PH01251-1-25-98

Filter

This machine is equipped with a 10 Micron filter on the return side of the circuit.

TX01496-3-3-98



PH02000-1-15-01



Read Before Operating

Before operating this machine, please read this manual thoroughly and keep a copy available for future reference.

Return manual to the protective storage box when not in use. This manual is to be considered part of your machine.



Stop-1228-95

TX00401-9-15-94

Check Oil Level

Check oil level in sight gauge on reservoir and add oil if necessary.

Refer to the "Hydraulic Fluids" section of this manual for hydraulic oil recommendations.



PH01251-22-98

TX01450-2-3-98

Diesel Engine

Read the operating and maintenance instructions for the engine before operating.

The key ignition has four positions. Preheat, off, run and start.

NOTICE: Switch the engine to slow speed before starting.

For cold weather starting, turn switch to preheat for no longer than 10 seconds. Never use starting fluid.

Turn the key and start the engine.

Confirm that all gauges read correctly.

Turn the key to OFF to stop the engine.

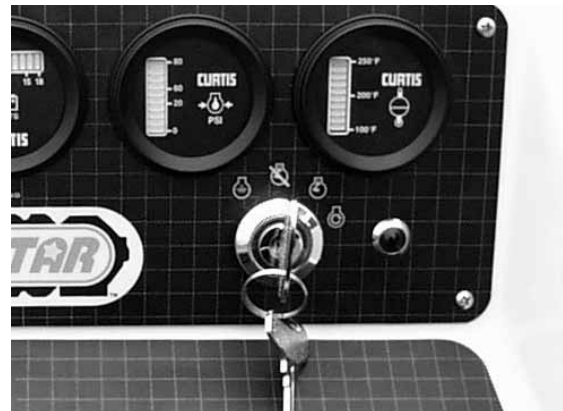

PH01261-2-12-98

TX02377-1-10-05



Operation



Moving Machine Into Position

Make sure all personnel are safely clear of the machine before moving.

Stand behind the machine console and start the engine.

Move both track control levers forward to go in a straight line. Release the levers to stop. Moving just the right track forward turns the machine to the left. Moving just the left track forward turns the machine to the right.

The track speed valve (A) is used to switch between low speed/high torque and high speed/low torque. The machine will not have torque available to turn in all conditions in high speed.



PH02290-4-17-02

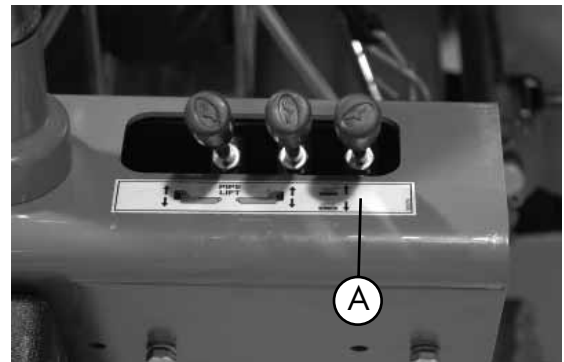

PH03297-9-18-06

TX02669-9-18-06

Prepare Heater

⚠ DANGER Heater Is Not Explosion Proof. Operation of heater in a hazardous environment without necessary safety precautions will result in explosion and death.

If operating in a hazardous environment, heater should be brought up to temperature in a safe environment, then unplugged before entering the hazardous atmosphere for fusion.

Install butt fusion heater plates.

NOTICE: Non-coated heaters should never be used without butt fusion heater plates installed. Refer to the "Maintenance" section of this manual for installation procedure.

Place heater in insulated heater stand.

Select low engine speed.

Plug heater into outlet on machine.

Select high engine speed at the console. Allow heater to warm-up to operating temperature.



PH02298-3-20-02

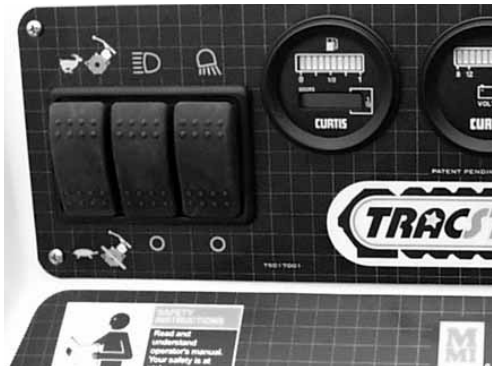

PH01263-2-12-98

TX01464-2-9-98



Operation



Set up Pipe Supports

Set up pipe stands and adjust height so the pipe is in line with the jaws.



PH012642-12-98

TX00367-9-15-94

Install Clamping Inserts

Select and install appropriate clamping inserts for the pipe that is being fused.



PH02283-4-2-02

TX00368-9-15-94

Loading Pipe into Machine

Clean the inside and outside of pipe ends that are to be fused.

Open the upper jaws and insert pipe in each pair of jaws with applicable inserts installed.

Let the pipe ends protrude more than 1" past the face of the jaws.



PH02300-4-17-02

TX01094-8-20-96



Operation



Fusion Settings and Controls

Refer to the **Fusion Control System** section of this manual to program fusion settings.

Refer to the **Overview** section of this manual for use of pendant controls.

TX01493-3-2-98



PH01260B-2-12-98

Positioning Pipe into Machine

Swing the facer into place. Move the carriage toward the fixed jaw, while watching the gap at each end of the facer guide rod brackets. When the pipe is in contact with the facer, this gap indicates the amount of material that will be trimmed from the pipe end. Assure sufficient material will be removed for a complete face off. Tighten the clamp knobs on the outside jaws. Hand tighten the inside clamp knobs.

TX01492-3-2-98



PH02302-4-17-02

Facing the Pipe

Open carriage until the pipe is not touching the facer.

Select facing pressure. Turn facer switch on

Close the carriage. If the facer stalls, adjust the facing pressure so the facer continues to cut.

IMPORTANT: When drag pressure exceeds 300 psi it is necessary to move the carriage to bring the pipe ends into contact with the facer before opening the facer valve.

Let the carriage bottom out on facer guide rod brackets. Turn facer off. Open the carriage so the facer can be removed.

NOTICE: Never extend the blade beyond the inner or outer circumference of the facer.



PH02303-4-17-02

TX02380-1-24-05

Remove Facer

Release the handle lock, and swing the facer out to the storage position.

Remove chips from pipe ends.

Do not touch faced pipe ends.

Inspect both pipe ends for complete face off. If the face off is incomplete, return to **Loading Pipe into Machine**.

Move the carriage to the left until ends of pipe butt together.

Check pipe joint for proper alignment.

WARNING Do not use finger to check for hi/lo (misalignment). The unit is under pressure, and slippage could result in crushed fingers. Always keep hands clear of the jaw area.

If pipe is not lined up, tighten the high side jaw to bring into alignment.

IMPORTANT: Always tighten the side that is higher, never loosen the low side.

When the pipe is properly aligned tighten outside clamps to insure against slippage.

Ensure there is no unacceptable gap between the pipe ends. If there is an unacceptable gap, return to **Loading Pipe into Machine**.

NOTICE: When clamping, do not over-tighten the clamp knobs because machine damage can result. Check to see if there is space between the upper and lower jaws. If the two jaws are touching, do not continue to tighten.

Bring the pipe ends together under fusion pressure to check for slippage. If slippage occurs, return to **Loading Pipe into Machine**.

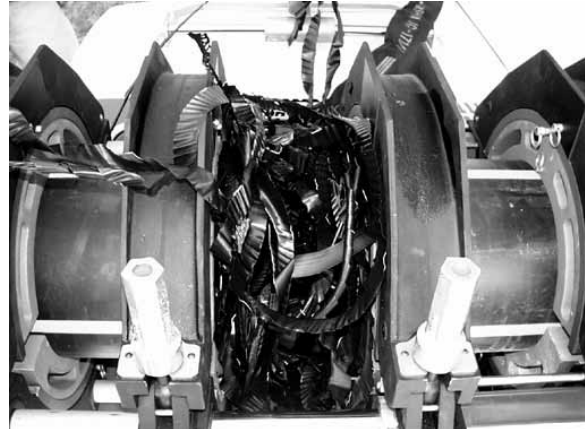

PH01290-3-98

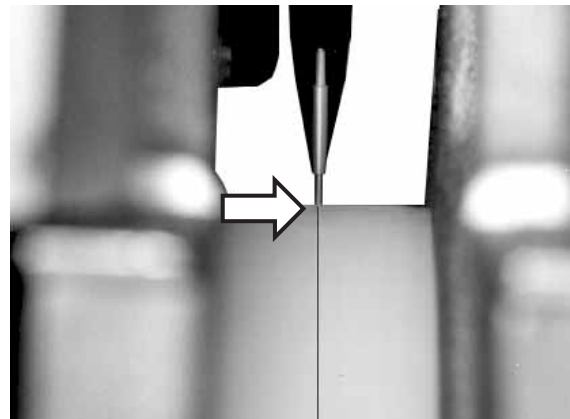

PH00357-9-12-94

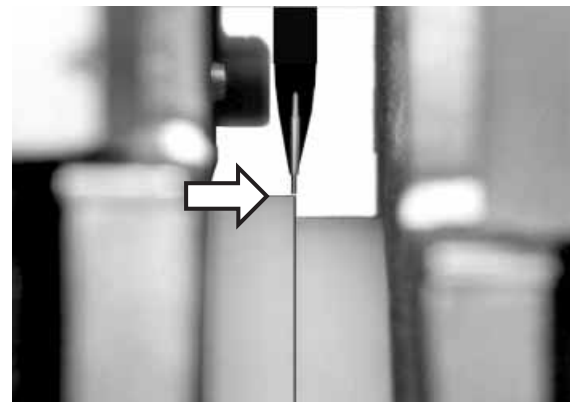

PH01267-2-12-98



PH01281-2-25-98



Operation



Position Carriage for Heater Insertion

Move the carriage to open a gap large enough to insert the heater.



PH02302-4-17-02

TX01462-2-9-98

Check Heater Temperature



Incorrect heating temperature can result in questionable fusion joints. Check heater plates periodically with a pyrometer and make necessary adjustments.

Check heater surface temperature.

Refer to the pipe manufacturer's recommendations for proper heater temperature.

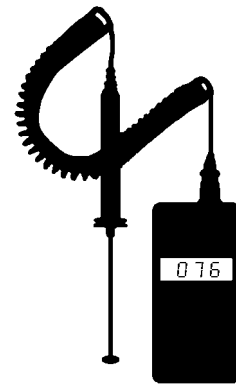

WR00077-4-16-93

IMPORTANT: The heater temperature shown on the pendant display screen is the measured internal temperature of the heater minus a programmed offset. If necessary, this offset may be changed in the system menu.

02/05/98 16:26	
▶Face:	100◀
Soak:	80
Fuse:	600
(Drag:	80)
440°F	

CD00425-2-26-98



TX02569-11-21-05



Operation



Select Fusion Pressure

Move the selector switch to fusion pressure.

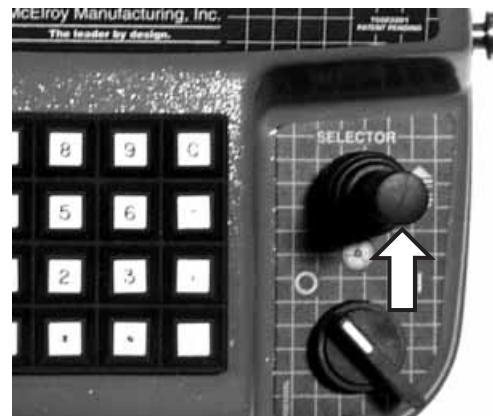

PH01303-3-5-98

TX01452-2-3-98

Inserting Heater



Heater Is Not Explosion Proof. This unit is not explosion proof. Operation of heater in a hazardous environment without necessary safety precautions will result in explosion and death.

If operating in a hazardous environment, heater should be brought up to temperature in a safe environment, then unplugged before entering the hazardous atmosphere for fusion.

Use a clean non-synthetic cloth to clean the butt fusion heater plate surfaces.

Verify heater temperature by noting the reading on the Control Pendant screen.

Insert heater between the pipe ends.

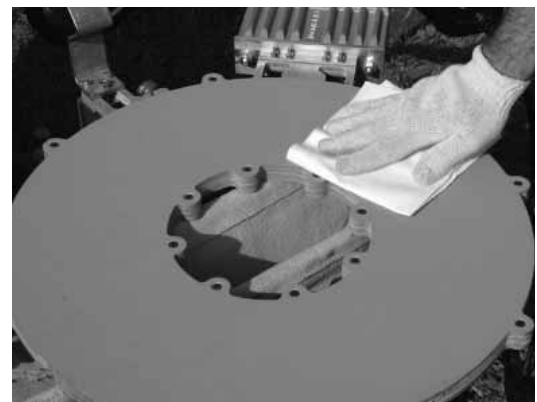

PH02306-4-17-02

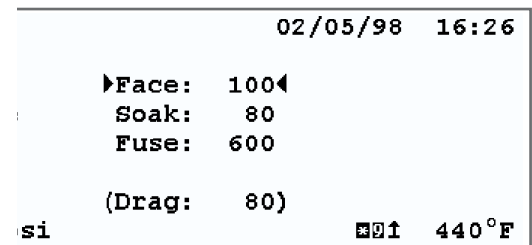

CD00425-2-26-98

TX01494-3-2-98



Heating the Pipe (Semi-Automatic Only)

Close the carriage, bringing the heater into contact with both pipe ends. Select Heat pressure from the pendant menu. If heater pressure is not required by pipe manufacturer, or opposing forces are not great enough to move the carriage away from the heater, shift the carriage directional control to neutral.

IMPORTANT: Always shift into the heating mode **before** returning carriage directional control to neutral.

Watch the Stopwatch and follow the pipe manufacturer's suggested heating and soaking procedure.

TX01459-2-9-98



PH01268-2-12-98



Fusing the Pipe (Semi-Automatic Only)

CAUTION Failure to follow the pipe manufacturer's heating time, pressure and cooling time may result in a bad joint.

After following the pipe manufacturer's suggested heating procedure, move the carriage direction control to neutral.

Select fusion pressure from the pendant menu.

Open the carriage just enough to remove the heater.

Quickly remove the heater and close the carriage, bringing the pipe ends together under the pipe manufacturer's recommended pressure.

Allow joint to cool under pressure according to pipe manufacturer's recommendation.

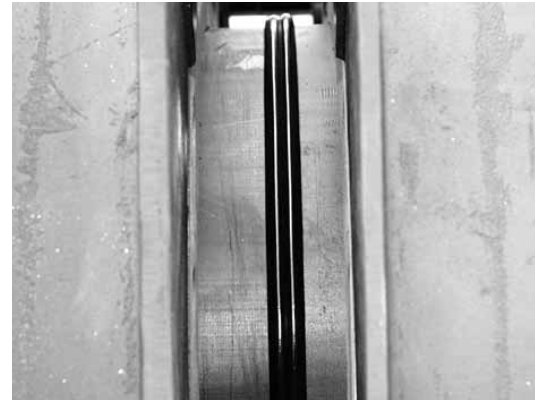

PH01269-2-13-98

TX01460-2-9-98

Opening Movable Jaws

After the joint has cooled for the pipe manufacturer's recommended time, shift the carriage control to the neutral position.

Loosen all clamp knobs, and open carriage far enough to open the jaw nearest the facer.

Open the movable jaws.



PH01270-2-13-98

TX01461-2-9-98

Opening Fixed Jaws

Open the fixed jaws.



PH01271-2-13-98

TX00381-9-16-94



Operation



Raise Pipe

Raise the joined pipe using the hydraulic pipe lift.



PH02301-4-17-02

TX00818-12-21-95

Position Pipe for Next Joint

Move the fusion machine to end of pipe, or pull the pipe through the jaws until the end of the pipe is protruding more than 1" past the jaw face of the fixed jaw.



PH02300-4-17-02

TX01091-8-20-96

Install Next Piece of Pipe

Insert a new piece of pipe in movable jaws and repeat all previous procedures.



PH02302-4-17-02

TX00384-10-12-95



Special Operations - In Ditch



Overview

The carriage may be removed and hoisted or hand carried into a ditch. The carriage needs to be stripped down to be hand carried or when sliding underneath the pipe.

NOTICE: Turn ignition key to off position before doing anything else.

TX01469-2-13-98

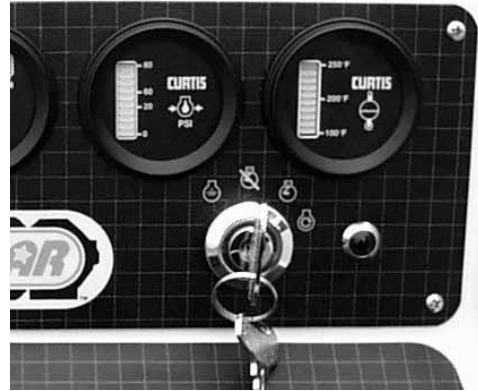

PH01261-2-12-98

Remove the Facer

Lower the facer into the carriage and remove the detent pin securing the facer to the pivot arm.

Disconnect hydraulic hoses.

Remove the facer from the carriage and place in the facer stand.

TX01477-2-26-98



PH02286-4-17-02

Remove Hydraulic Hoses

Disconnect the hydraulic hoses from the carriage.

TX01478-2-26-98

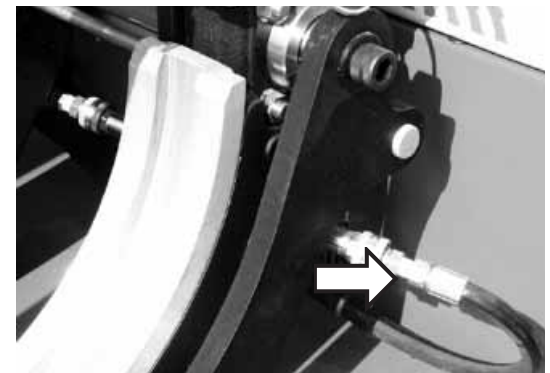

PH01277-2-26-98



Removing Outer Fixed Jaw

If the carriage is going to be hand carried, or used for fusing to a tee, the outer fixed jaw needs to be removed.

Remove the outer fixed jaw braces.

Remove the two bolts that attach the 3-Jaw skid to the 4 jaw skid.

The 3-Jaw skid can now be lifted out of the 4-Jaw skid leaving the outer fixed jaw behind.



PH012269-4-2-02



PH012269-4-2-02

TX01501-3-9-98

Removing Top Jaws

If the carriage is going to be hand carried, or if the carriage needs to be hoisted and slid underneath the pipe, the top jaws need to be removed.

Loosen all clamp knobs. Take out the detent pins securing the top jaws and remove the jaws.

TX01479-2-26-98

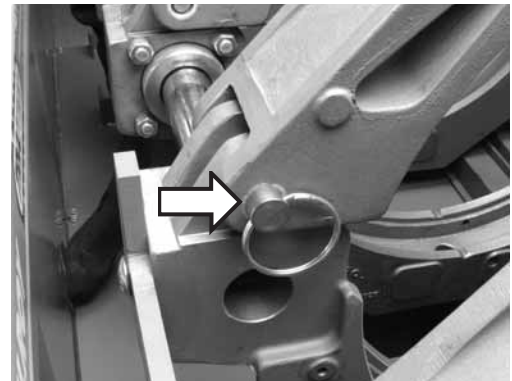

PH02284-4-17-02

Changing Operating Sides

The top jaws may be turned around to open on the other side of the carriage. With the jaws off, use one of the detent pins to push out the detent pins securing the clamp knob eyebolts. Reinstall the clamp knob eyebolts on the other side of the carriage. Turn the top jaws around and secure in place with detent pins.

TX01502-3-9-98



PH01306-3-12-98



Special Operations - In Ditch



Changing Carriage Direction Control

The operator may reverse the carriage direction control when operating the carriage from the other side of the machine. If the directional control is not reversed, the carriage moves to the right when the control is pushed to the left.

Reverse the Carriage Directional Control by pressing *9 on the control pendant.

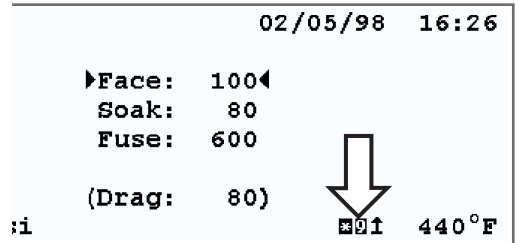

TX01503-3-9-98

CD004253-12-98

Removing Carriage

Remove the rod that locks the carriage to the frame. The carriage can now be lifted and removed. Make sure hydraulic hoses are disconnected.



TX01480-2-26-98

PH022644-2-02

Remove Control Pendant

Unscrew and detach the cable on the back side of the pendant. Unscrew the knob on the pendant arm and remove the pendant.

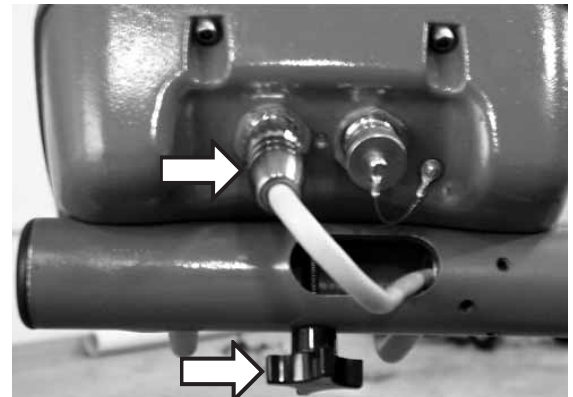

TX01481-2-26-98

PH012953-4-98

Attach Extension Cable

Connect the extension cable to the control pendant and to the existing cable on the pendant arm.

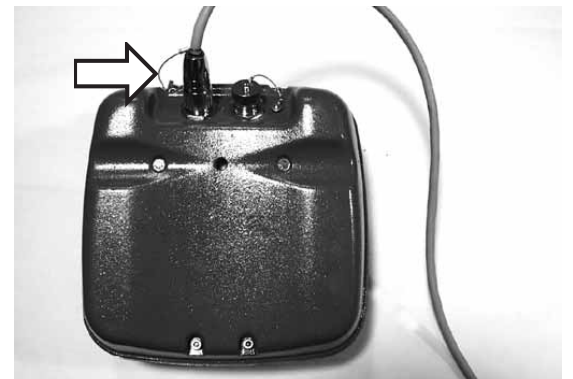

TX01482-2-26-98

PH013003-4-98



Special Operations - In Ditch



Attach Linear Transducer Extension Cable

Disconnect the linear transducer cable from the mating chassis cable by unscrewing the silver connector ring.

Fasten one end of the linear transducer extension cable to the transducer cable connector. Fasten the other end of the extension cable to the chassis cable connector.

TX02383-02-04-05

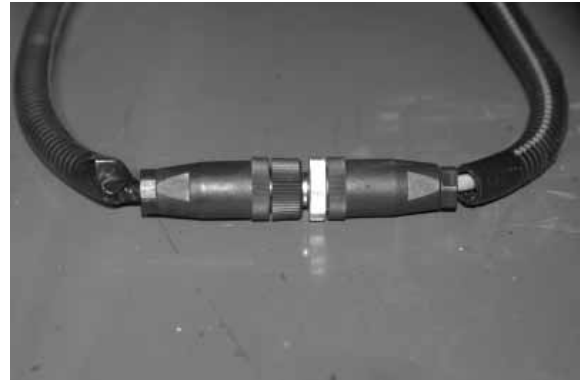

PH02813-2-4-05

Lower Carriage Into Ditch

Attach lifting strap to lifting ring on the side of the carriage.

Connect the hydraulic hoses to each other to keep dirt out of the connectors.

Find a good balance point for the lifting strap.

Lift the carriage assembly and lower into ditch.

TX02012-4-29-02

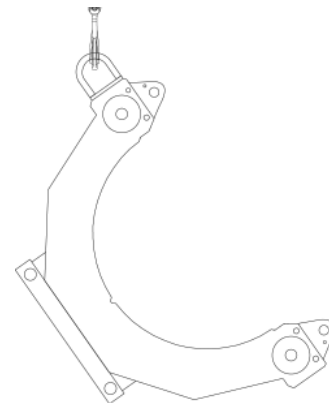

CD00411b-4-29-02

Position Carriage Under Pipe

Position carriage assembly on side of the pipe. Lift pipe and slide carriage assembly under pipe.

Rotate carriage assembly around to a normal upright position.

TX01476-2-26-98

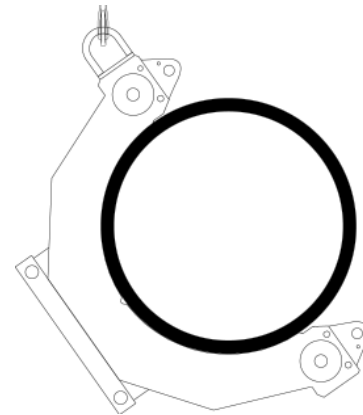

CD00412b-4-29-02

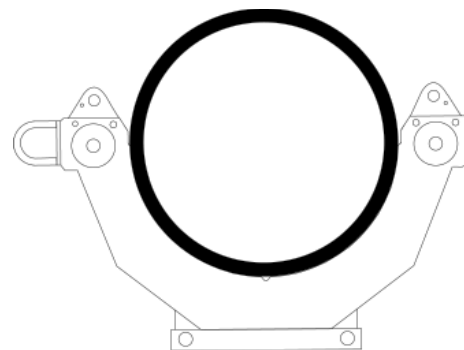

CD00413b-4-29-02



Special Operations - In Ditch



Attach Upper Jaws

Attach the top jaws and clamp around pipe.

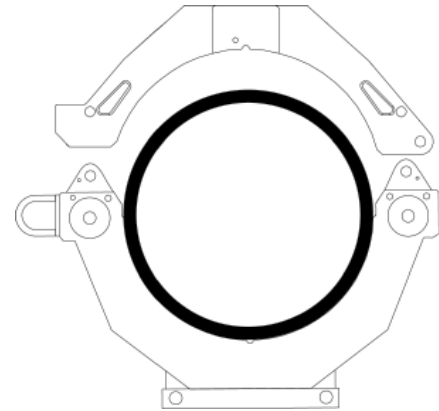

CD00414b-4-29-02

TX01484-2-26-98

Attach Hydraulic Hoses

There are two sets of hydraulic extension hoses. One set connects to the carriage hoses on the machine and to the carriage. The other set connects the facer hoses on the machine to the facer.

Connect all hoses.



PHO1299-3-4-98

TX02011-4-29-02

Make Fusion Joint

Refer to the "Butt Fusion Procedure" for operating instructions.
After facing operation, remove the facer from ditch.

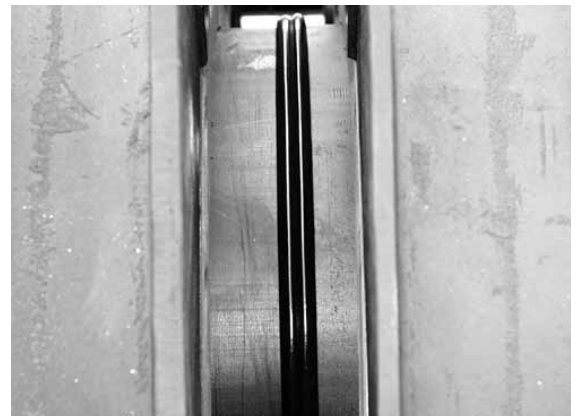

PHO1269-2-13-98

TX00450-9-16-94

Remove Upper Jaws

Loosen clamp knobs, pull ball lock pins and remove the top jaws.

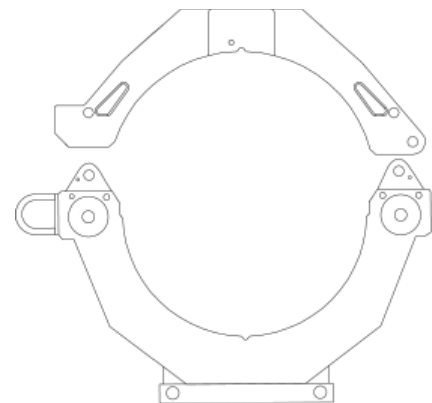

CD00410b-4-29-02

TX01486-2-26-98



Special Operations - In Ditch



Remove Hydraulic Hoses

Disconnect hydraulic hoses to carriage and remove hoses from ditch.



PH01299-3-4-98

TX01487-2-26-98

Remove Carriage From Ditch

Attach sling to lifting ring.
Rotate carriage assembly from under pipe.
Lift carriage assembly from ditch.

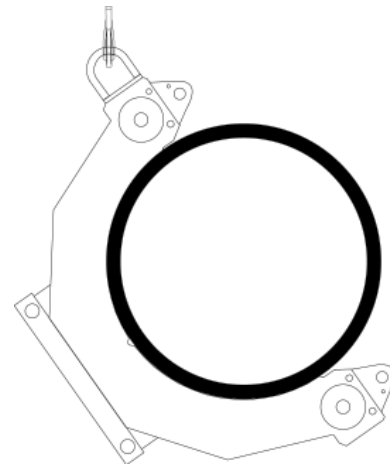

CD00412b-4-29-02

TX02013-4-29-02



Heavy Overhead Load



Fusion machine and plastic pipe are heavy. If loaded or lifted improperly, they could crush or kill. Handle load carefully with proper overhead rigging and equipment of adequate load rating.

TX00062-3-8-93

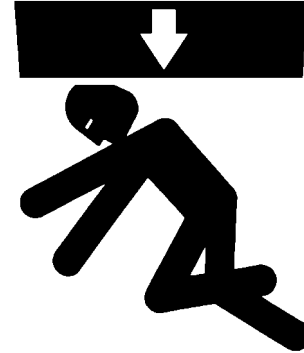

WR0001-4-3-8-93

Crush Points



Crush points exist on this machine. Keep hands and body parts away from the machine. Be aware of yourself and others when moving equipment.

TX01895-11-15-00

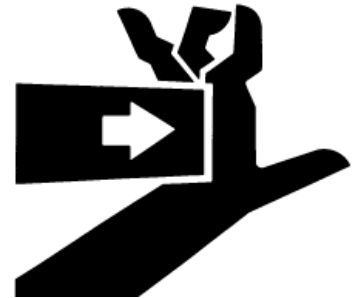

WR0001-2-12-4-92

Required Equipment

- Proper overhead rigging and equipment of adequate load rating to lift the fusion machine.
- Lifting Sling - (supplied with machine)

Notice: Check all equipment to confirm that it is in good working order.

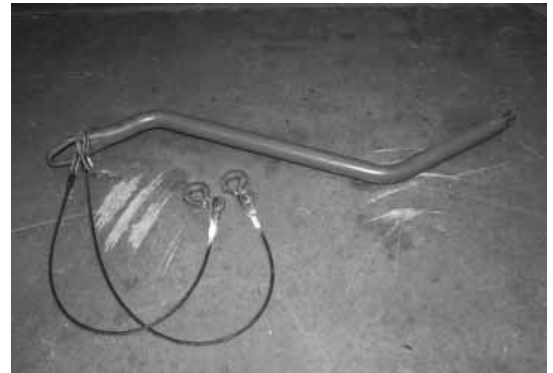

PH02745-11-29-04

TX01881-11-10-00



Special Operations - Lifting the Machine



Attach Slings

Attach the sling to the lift points on the machine. The steel tube goes to the outside of the machine, the shorter cable with white sleeve goes to the rear of the machine as shown in picture A, and the longer cable with the yellow sleeve goes to the front of the machine as shown in picture B.

Route the yellow cable under the carriage as shown in the picture.



PH02761-1-10-05

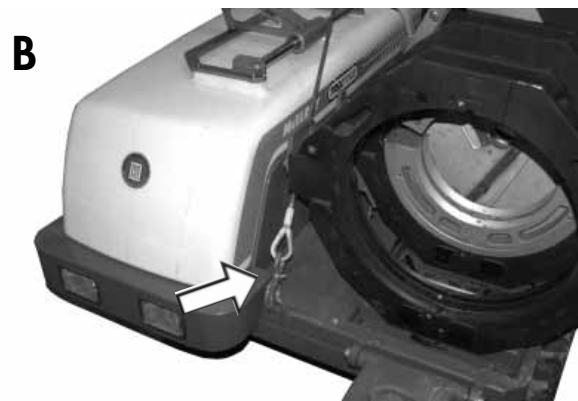

PH02762-1-10-05

TX02358-11-29-04

Lifting Safety

Follow all applicable federal, state, local, and industry specific regulations when lifting unit.

Never carry loads over people.

TX00410-10-12-93



SAFE1ST-12-14-92



Fusion Control System



TracStar[®] Operator Interface

The TracStar[®] Operator Interface provides communications between the operator and the McElroy Fusion Control System. In addition to providing the familiar operation of a McElroy semi-automatic fusion machine, the TracStar[®] Operator Interface has a built in stopwatch and fusion pressure calculator.

The Semi-Automatic screen is shown below: (Press *+ or *- to adjust the contrast of the screen)

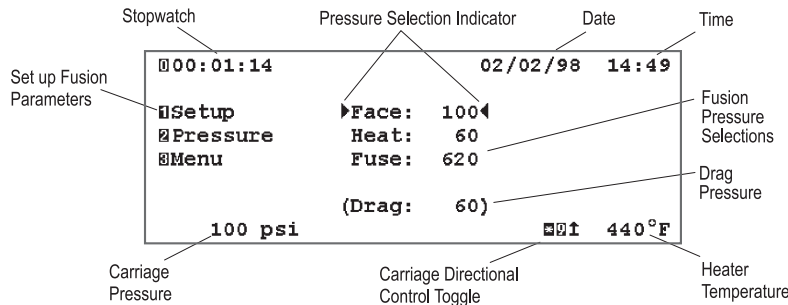

CD000415-2-26-98

In this screen you may press 0 on the keypad to reset the *stopwatch*. Press 1 to setup *fusion parameters*. Press 2 to set the currently selected pressure. Press 3 to access other menus. Press the * key followed by 9 to toggle the *carriage directional control*.

At the lower left hand corner is the carriage pressure showing the current carriage pressure. An X appears in front of all pressure readings except for *face* pressure. Facing pressure is the only pressure that can be varied with the pressure adjustment knob.

The pressure selection indicators surrounds the currently selected pressure. This is the pressure which the Fusion Control System is currently maintaining. The pressure can be changed by pressing 2 on the key pad and typing in a new pressure. In the above example, the currently selected pressure is *Face*, and you can select *Heat* pressure using the *pressure selector lever*. You may assign up to five pressures, namely *Face, Heat, Soak, Fuse, and Cool*.

The last measured drag pressure is displayed in parenthesis. In the example above, the last measured drag pressure is 60 psi, and it is included in the fuse pressure of 620 psi. In other words, if the theoretical fuse pressure (without drag) is 560 psi.

On the top right hand corner is the current date and time. The time is in 24 hour format showing hour and minutes.

On the bottom right hand corner is the heater temperature.

To the left of temperature gauge is the *carriage directional control orientation* icon. The upward pointing arrow is replaced by a downward pointing arrow when the orientation is changed. The change in orientation allows you to control the carriage direction from either side of the carriage.

In all data entry screens, the C key is used as a backspace key to clear the last digit entered. The C key is also used to backup one screen in most cases.

TX02572-11-21-05



Fusion Control System



Setting up to Fuse Pipe in the Semi-Auto Mode

You may choose to fuse pipe using the semi-automatic mode, or set up the Datalogger[®] mode to record your fusion process. This section discusses the semi-auto fusion mode.

While in the semi-auto screen, select the facing pressure using the pressure selector lever. You may adjust the carriage pressure using the pressure adjustment knob to position the pipes. Face the pipes, check for hi-lo and slippage. Using the carriage control lever, position the pipes one (1) inch apart to prepare for drag measurement. Make sure that the pipes are properly prepared for the next step.

Press 1 on the keypad to setup fusion parameters.

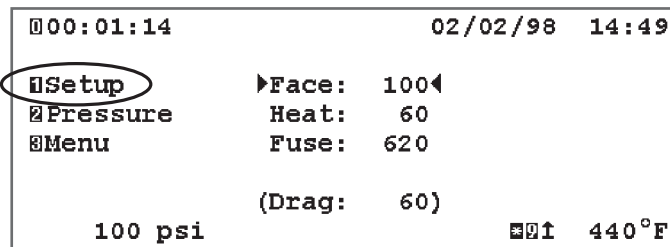

CD00416-2-26-98

Entering Pipe Parameters

You will be prompted to enter pipe size and interfacial pressures necessary to compute recommended gauge pressures for the fusion. You are also required to enter a heater temperature and a drag pressure. The drag pressure, which you are required to measure, will be added to the calculated pressures. These calculated pressures will be displayed in the pressure selection section of the screen.

The first data entry screen prompts you to select a pipe resin. You may scroll through the list of pipe resins to select the resin you are about to fuse. You may use — if

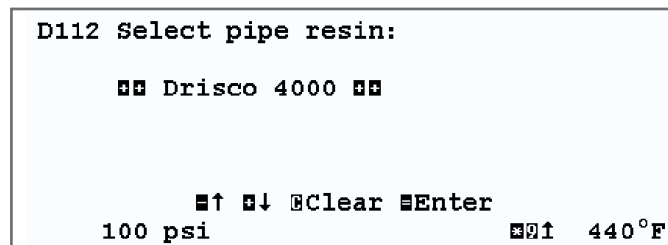

CD00417-2-26-98

your resin is not on the list. The - and + keys are used to scroll the resin list. The C Key takes you back to the previous screen. The = key enters your selection into the system and goes on to the next screen.



Fusion Control System



The next screen prompts you for heater temperature. Type in the pipe manufacturer recommended heater temperature using the numeric keypad. Use the C key for backspace, and press = to enter the temperature and go on to the next screen.

```

S030 Heater Temperature (°F): _

01234567890 CClear =Enter
100 psi          =01 440°F

```

CD004182-26-98

Piston area for the standard TraStar[®] 500 is 6.013 in, if a different carriage is used, you type in the piston area shown on the carriage. Otherwise, press = to accept the default 6.013 in piston area. Press = to enter the correct piston area and go to the next screen.

```

S014 Pipe Size: _

▶" IPS
" DIPS
" OD
mm OD
01234567890 =↑ =↓ CClear =Enter
100 psi          =01 440°F

```

CD004202-26-98

Pipe size can be entered in four different units (IPS, DIPS, inch OD, and mm OD). Use the - and + keys to select from one of the four units, then type in the pipe size and press = for the next screen.

Use the - and + keys to select from one of the three wall thickness units (DR, inches,

```

S018 Pipe Wall Thickness: _

▶DR
" WT
mm WT

01234567890 =↑ =↓ CClear =Enter
100 psi          =01 440°F

```

CD004212-26-98

and millimeters), then type in the wall thickness and press = to move on. If you have previously entered a wall thickness, you may press = to automatically paste it in the data entry field then press = to move on instead of having to retype the wall thickness. This is true for all data entry screens.



Fusion Control System



Next, you will be prompted for interfacial pressures (*heat, soak, fuse, and cool*). You may not need all four to complete your fusion, but some pipe resin do require all four. Most pipes manufactured in the USA require two interfacial pressures, *soak* and *fuse*. If you prefer *soak* and *cool*, you may do so by skipping the other interfacial pressures using the - key.

```

D122 Heat(psi): _

      (Interfacial pressure)

01234567890  #Skip #Clear #Enter
100 psi          #0f 440°F
  
```

CD00422-2-26-98

If you need heat pressure, simply type in the heat interfacial pressure and press =. *It is important to type in the **interfacial pressure** and not the gauge pressure. For a given interfacial pressure, a small piston area requires a higher gauge pressure than a machine with a larger piston area.*

Normally, the pipe is soaked under no interfacial pressure, and you enter 0 for soak pressure. In the soak cycle, you will be using 0 + drag pressure. You will be prompted to enter a drag pressure at a later screen.

```

C092 Use these parameters?
Drisco 4000 12" IPS DR 11
Heat(IFP): -----
Soak(IFP):    0 psi      440°F
Fuse(IFP):   75 psi     6.013in²
Cool(IFP):   -----
      #Yes. #Enter new data
100 psi          #0f 440°F
  
```

CD00423-2-26-98

At the end of the data entry screens, you will be asked to confirm your data entry. After verifying that the data entered is correct, press + to go on. If you need to change any of the data item, press - to make any corrections. Since you have entered all the data items once, you may press = to enter those items automatically instead of retyping all of them.

```

S010 Drag Pressure (psi): _

01234567890  #Set #Clear #Enter
20 psi          #0f 440°F
  
```

CD00424-2-26-98



Fusion Control System



The TracStar[®] computer automatically lowers the carriage pressure to minimum so that you can measure drag correctly. As a reminder, it would be ideal if the pipes were faced off and positioned for drag measurement (pipes 1 inch apart) before coming into this screen. Also, make sure the face pressure is selected so that the X mark is not shown at the lower left hand corner of the screen.

The proper way to measure drag is to set the carriage control lever in the "close carriage" position, then dial the pressure adjustment knob until the carriage begins to move. On the first sign of carriage movement, put the carriage control lever to neutral (center position) and wait for the pressure gauge (at lower left hand corner) to settle down. Press the + key to set the drag pressure. Press the = key to accept the pressure and go on to the next screen. Note, you may also type in a drag pressure using the keypad.

You will come back to the semi-auto screen after entering all the pertinent fusion

```

03:18:07                02/05/98  16:26

[Setup      ▶Face:  100◀
[Pressure    Soak:   80
[Menu       Fuse:   600

                (Drag:  80)

100 psi                [F  440°F
  
```

CD000425-2-26-98

information. At this point, you may follow the pipe manufacturer's fusion procedure to fuse the pipe.

If at any time you feel you need to increase or decrease any of the pressures, you may select that pressure using the selector and press 2 to change the pressure.

```

S034 Pressure (psi): _

[1234567890 [Clear [Enter

100 psi                [F  440°F
  
```

CD000425-2-26-98

Type in a pressure and press = to go back to the semi-auto screen.

```

03:18:07                02/05/98  16:26

[Setup      ▶Face:  100◀
[Pressure    Soak:   80
[Menu       Fuse:   600

                (Drag:  80)

100 psi                [F  440°F
  
```

CD000425-2-26-98

You may use the stopwatch on the upper left corner of the screen to time your fusion. The stopwatch runs continuously, and it can be reset to 00:00:00 by pressing 0 at any time during the fusion.



Setting Up DataLogger® Mode



Setting up to Fuse Pipe in the DataLogger® Mode

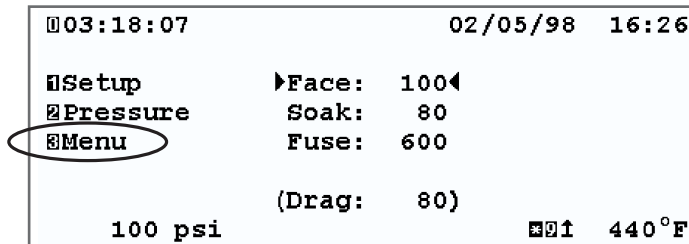

CD000427-2-19-98

While in the semi-auto screen, select the facing pressure using the pressure selector lever. You may adjust the carriage pressure using the pressure adjustment knob to position the pipes. Face the pipes, check for hi-lo and slippage. Using the carriage control lever, position the pipes one (1) inch apart to prepare for drag measurement. Make sure that the pipes are properly prepared for the next step.

From the semi-auto screen, press 3 to access the main menu.

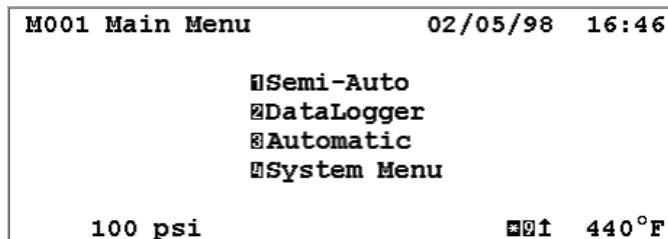

CD000669-1-10-05

Press 2 to access the DataLogger®

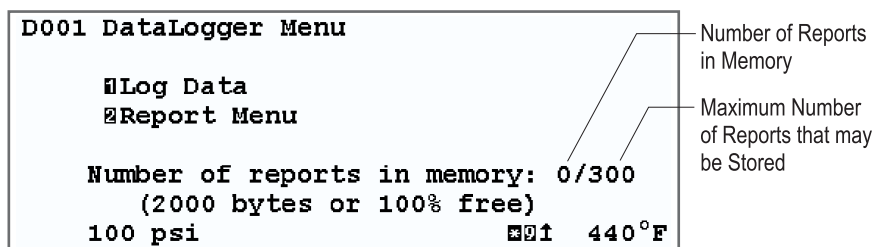

CD000429-2-19-98

The DataLogger® menu offers two options: log data or report menu. It shows you how many reports were logged, and the maximum number of reports you are allowed to store. It also shows you the number of bytes free (not used) in the report memory and the percentage free.



Setting Up DataLogger® Mode



Press 1 to log data.

```

C100 Machine ID: _

01234567890 Space Clear Enter
Alphabets

100 psi 01 440°F

```

CD004302:1998

You will be prompted to enter a machine identification. It may be the machine's serial number, or a name that you gave the machine.

In this screen, you may enter both alphabets and digits. Use the + and - keys to step up and down the alphabets A through Z. In the alphabet mode, press . to enter the selected alphabet for the current character space, so that you can prepare to select a different alphabet for the next character space. At any time during alphabet entry, you may press any digit key (0 through 9) to stop alphabet mode and enter a numeric digit.

Use the combination of * and . to enter a white space between characters. As always, the C key is used as backspace for data entry corrections, and the = key completes the data entry and proceeds to the next screen.

The employee number may also consist of alphabets and digits. Follow the

```

C102 Employee No.: _

01234567890 Space Clear Enter
Alphabets

100 psi 01 440°F

```

CD004312:1998

instructions for the *machine ID* screen above.



Setting Up DataLogger® Mode



```

C104 Job No.: _

01234567890 [Space] [Clear] [Enter]
               [Alphabets]

100 psi                               [01] 440°F

```

CD000432-19-98

The job number may consist of alphabets and digits. Follow the instructions for the machine ID screen above.

The joint number is a number-only data field. Use the keypad (0 through 9) to enter

```

C106 Joint No.: _

Previous: 0

01234567890 [Clear] [Enter]
100 psi                               [01] 440°F

```

CD000433-2-19-98

an integer number (1 through 9999). If you press = without entering a number, the computer automatically increments the previous joint number by 1 and makes it the current joint number.

```

C090 Use these identifications?

Machine ID: TS980315
Employee No.: M01432
Job No.: 98MAR001
Joint No.: 1
        [Yes] [Enter new data]
100 psi                               [01] 440°F

```

CD000434-2-19-98

At the end of identification data entry, you are asked to confirm your entries. If every entry is correct, press + to go on. If you need to change one of the fields, press -. You do not have to retype all the fields. You may press = and have the computer recall what you typed in previously, press = again to go on to the next screen.



Setting Up DataLogger[®] Mode



Entering Pipe Parameters

After entering identification data, you will be prompted for pipe parameters. Please refer to *Entering Pipe Parameters* under the *Setting up to Fuse Pipe in the Semi-Auto Mode* section for instructions on entering pipe parameters. If you have previously entered pipe parameters, you will be prompted to confirm the data entered as follows:

```

C092 Use these parameters?
  Drisco 4000 12" IPS DR 11
  Heat(IFP): -----
  Soak(IFP):    0 psi      440°F
  Fuse(IFP):   75 psi      6.013in2
  Cool(IFP): -----
            Yes.   Enter new data
100 psi                                 01 440°F

```

CD000435-2-19-98

You will be prompted to measure drag for each joint in the DataLogger[®] mode.

```

S010 Drag Pressure (psi): _

 01  02  03  04  05  06  07  08  09  10  Set  Clear  Enter
20 psi                                 01 440°F

```

CD000436-2-19-98

Follow the procedure described in the *Setting up to Fuse Pipe in the Semi-Auto Mode* section for proper drag measurement.

After entering drag pressure, the recommended fusion pressures are computed and displayed in the pressure selection section of the screen.

```

000:48:32                                02/06/98 09:34
 Pressure
 Log

           (Drag: 80)
100 psi                                 01 440°F

```

Note: In the original image, a circle highlights the 'Face: 100', 'Soak: 80', and 'Fuse: 600' values.

CD000437-2-19-98

At this point, you are ready to log data. Check to make sure the heater is up to temperature, then install the heater between the pipes. Use the pressure selector lever to select fuse pressure for closing the pipes against the heater.



Setting Up DataLogger[®] Mode



Just before switching the carriage control lever to close on the heater, press 4 on the keypad to enter into the data logging mode.

```

00:56:14                02/06/98  09:42
                                Face:  100
  Pressure                Soak:   80
  Log                      Fuse:  600
  (Drag:  80)
X  600 psi                440°F

```

CD00438-2-19-98

Once the pipes contact the heater, shift into soak pressure and wait for the pressure gauge to read soak pressure, then shift the carriage control lever to neutral.

```

00:00:03                02/06/98  09:52
                                Face:  100
  Pressure                Soak:   80
  Stop                    Fuse:  600
  Logging
  (Drag:  80)
X  80 psi                440°F

```

CD00439-2-19-98

Press 0 to reset the stopwatch to time your soak cycle. At the end of soak, shift the pressure selector to fuse pressure, and prepare to remove the heater.

Open the carriage and remove the heater quickly, then close the carriage to join the pipes. Press 0 to reset the stopwatch to time your fuse cycle.

At the end of the fuse cycle, press 6 to stop logging data, then center the carriage control lever.

```

D150 DataLogging Stopped!
      (STOP key pressed)

  View Report
  Continue

X  600 psi                440°F

```

CD00440-2-19-98



Setting Up DataLogger® Mode



The computer informs you that the logging was stopped because you pressed 6 to stop it. Data logging can also be stopped if the report memory is full, or the maximum log time of 6550 seconds (1 hour 49 minutes) is reached.

You will be given an option to either view the report or continue logging the next joint. If you want to view report, press +.

You will be shown the report and pressure profile of the joint. Use the - and + key to navigate the report pages.

```

D182 Joint report page 1:
  1. Date and Time: 02/06/98  09:52:12
  2. Joint Number : 1
  3. Job Number   : 98MAR001
  4. Employee No. : M01432
  5. Machine ID   : TS980315
      █
X   600 psi                █ 440°F

```

CD00441-2-1998

```

D184 Joint report page 2:
  6. Machine Model: TracStar 500
  7. Piston Area  : 6.01 in2
  8. Pipe Material: Drisco 4000
  9. Pipe Size    : 12" IPS  DR 11
      █ █
X   600 psi                █ 440°F

```

CD00442-2-1998

```

D186 Joint report page 3:
Interfacial Pressures:
12. Heat          : -----
13. Soak          :      0 psi
14. Fuse          :      75 psi
15. Cool          : -----
      █ █
X   600 psi                █ 440°F

```

CD00443-2-1998



Setting Up DataLogger® Mode



```

D188 Joint report page 4:
Recommended Gauge Pressures:
18. Heat      : -----
19. Soak      :    80 psi
20. Fuse     :    600 psi
21. Cool      : -----
                ■ ■
X   600 psi                *01 440°F

```

CD004442-19-98

```

D190 Joint report page 5:
Recorded Data:
24. Drag Pressure:    80 psi
25. Heater Temperature: 440°F
                ■ ■
X   600 psi                *01 440°F

```

CD004452-19-98

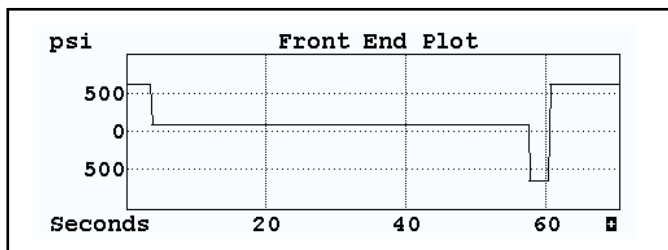

CD004465-4-98

The front end plot highlights the soak cycle so that you can determine if the shift sequence was done properly. A proper pressure shift sequence allows the carriage pressure to go to drag pressure quickly. An improper sequence may trap pressure.

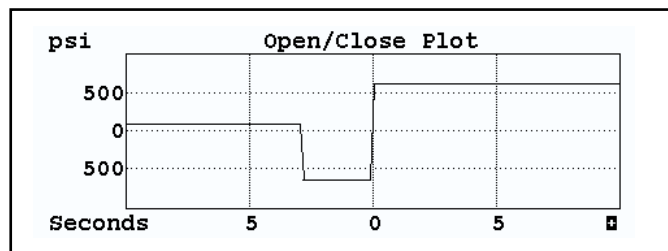

CD004472-19-98

The Open/Close plot "zooms in" on the period of time in which the heated pipe ends are removed from the heater and are fused together.

A summary plot shows the pressure profile for the entire fusion process until the end of data logging.



Setting Up DataLogger® Mode



```
D160 Print report?  
  
X 600 psi          Yes No          1 440°F
```

CD000448-2-19-98

After viewing the report on the screen, you may print it out on the optional portable printer. Make sure you have the proper printer cable. Turn on the printer and press +.

The next screen asks if you want to make another joint.

```
D170 Log another joint?  
  
Number of reports in memory: 1/300  
      (1802 bytes or 90% free)  
  
X 600 psi          Yes No          1 440°F
```

CD000449-2-19-98

It also tells you how many joints are currently in the report memory, and how much memory is left to store new joint reports.

If you want to make another joint, press +. You will be prompted to confirm the identification and pipe parameters entered previously. You may choose to use the same information entered previously, or modify any data field as described earlier in this section.



Setting Up Automatic Mode



Setting up to Fuse Pipe in the Automatic Mode

On power up, all Coach™ systems with automatic feature will display the AutoMc menu:

```

A001 AutoMc Menu

  1 Fuse Pipe
  2 Report Menu

Number of reports in memory: 0/300
(2000 bytes or 100% free)
100 psi                1 440°F
  
```

Number of reports in memory

Maximum number of reports you can store

The AutoMc® menu offers two options: Fuse Pipe or Report Menu. It shows how many reports were logged, and the maximum number of reports you are allowed to store. It also shows the number of bytes free (not used) in the report memory and the percentage free.

Press 1 to fuse pipe.

You will be prompted to enter machine identification. It may be the machine's serial number or a name you assigned the machine.

```

C100 Machine ID: _

01234567890  Space Clear Enter
              Alphabets

100 psi                1 440°F
  
```

In this screen, you may enter both alphabets and digits. Use the + and - keys to step up and down the alphabets A through Z. In the alphabet mode, press . to enter the selected alphabet for the current character space, so that you can prepare to select a different alphabet for the next character space. At any time during alphabet entry, you may press any numeric key (0 through 9) to stop alphabet mode and enter a numeric digit.

Use the combination of * and . to enter a white space between characters. As always, the C key is used as backspace for data entry corrections, and the = key completes the data entry and proceeds to the next screen.



Setting Up Automatic Mode



```

C102 Employee No.: _

01234567890  ##Space  @Clear  #Enter
              ##Alphabets

100 psi                      ##01  440°F

```

CD00672-1-10-05

The employee number may also consist of alphabets and digits. Follow the instructions for the machine ID screen above.

```

C103 Passport No.: _

01234567890  ##Space  @Clear  #Enter
              ##Alphabets

100 psi                      ##01  440°F

```

CD00673-1-10-05

The passport number may also consist of alphabets and digits. Follow the instructions for the machine ID screen above.

```

C104 Job No.: _

01234567890  ##Space  @Clear  #Enter
              ##Alphabets

100 psi                      ##01  440°F

```

CD00674-1-10-05

The job number may consist of alphabets and digits. Follow the instructions for the machine ID screen above.



Setting Up Automatic Mode



```

C106 Joint No.: _

Previous: 0

01234567890 [C]Clear [E]Enter
100 psi [F] 440°F

```

CD00675-1-10-05

The joint number is a number-only data field. Use the keypad (0 through 9) to enter an integer number (1 through 9999). If you press = without entering a number, the computer automatically increments the previous joint number by 1 and makes it the current joint number.

```

C090 Use these identifications?
Machine ID: TS980315
Employee No.: M01432
Passport No.: P321
Job No.: 98MAR001
Joint No.: 1
[+]Yes. [E]Enter new data
100 psi [F] 440°F

```

CD00676-1-10-05

At the end of identification data entry, you are asked to confirm your entries. If every entry is correct, press + to go on. If you need to change one of the fields, press -. You do not have to retype all the fields. You may press = and have the computer recall what you typed in previously, press = again to go on to the next screen.

Entering Fusion Parameters

After entering identification data, you will be prompted to enter fusion parameters if not already entered. A password is required to add or change fusion parameters. Once the correct password is entered, you are guided step-by-step to complete the entries:

```

D112 Select pipe material

[+] Drisco 4000 [+]

[+] [F] [D] [C]Clear [E]Enter
100 psi [F] 440°F

```

CD00677-1-10-05



Setting Up Automatic Mode



The first data entry screen prompts you to select a pipe material. You may scroll through the list of pipe resins to select the resin you are about to fuse. You may use `—` if your resin is not on the list. The - and + keys are used to scroll the resin list. The C Key takes you back to the previous screen. The = key enters your selection into the system and goes on to the next screen.

```

S014 Pipe OD (mm) :_

mm OD
01234567890    [C]Clear [E]Enter
100 psi          [0]0 [1] 440°F
  
```

Type in the pipe size and press = for the next screen.

```

S018 Pipe SDR/DR: _

01234567890    [C]Clear [E]Enter
100 psi          [0]0 [1] 440°F
  
```

Type in the wall thickness and press = to move on. If you have previously entered a wall thickness, you may press = to automatically paste it in the data entry field then press = to move on instead of having to retype the wall thickness. This is true for all data entry screens.

CD00703-11-1-05

CD00704-11-1-05



Setting Up Automatic Mode



```
C092 Use these parameters?
Drisco 4000 12" IPS DR 11
Heat: 00:10 75 psi →←00:07
Soak: 1:30 0 psi 440°F
Fuse: 2:30 75 psi
Cool: 3:00 50 psi 6.013in2
  Yes. Enter new data
100 psi 440°F
```

CD00682-1-10-05

At the end of the data entry screens, you will be asked to confirm your data entry. After verifying that the data entered is correct, press + to go on. If you need to change any of the data items, press - to make any corrections. Since you have entered all the data items once, you may press = to enter those items automatically instead of retyping all of them.



Setting Up Automatic Mode



Fusing Pipe in Automatic Mode

After entering identification data and fusion parameters, you are prompted to prepare the pipe for fusion:

```
A170 Prepare pipe for fusion:
      (1) Face Pipe
      (2) Check Hi/Lo

      Press + to proceed
100 psi                               + 440°F
```

Prepare the pipe for fusion by manually facing the pipe ends, checking hi/lo, and check for slippage. Once the pipes are prepared, press + to continue.

A warning message will appear before automatic mode begins.

```
A172 Machine in Automatic mode.

      Carriage will move automatically.

      Press + to proceed
100 psi                               + 440°F
```

Press + to continue, and the carriage movement alarm will sound. The carriage moves automatically to measure drag pressure. After the drag pressure is measured, the required carriage pressures are automatically calculated and checked to make sure these pressures are attainable. Follow the next prompt to manually clean and install the heater.

```
A210 Install Heater:
      (1) *Optional* Add/Edit
           External Probe Temp: ---
      (2) Clean and install heater
      (3) Press + to proceed
           Carriage closes automatically!!
100 psi                               + 440°F
```

Press + to continue, the carriage closes automatically against the heater. The heat cycle begins followed by the soak cycle. At the end of the soak cycle, the heater is removed manually when prompted.

CD00705:11-1-05

CD00684:1-10-05

CD00685:1-10-05



Setting Up Automatic Mode



Heater Removal Procedure

10 seconds before the end of the soak cycle, the alarm will sound to indicate heater is almost ready for removal. The operator should be positioned to remove the heater. The alarm will continue to sound at 1 second intervals until the soak cycle timer counts down to 0. At the end of the count down, the carriage opens automatically, and the heater must be removed as quickly as possible. The total carriage open and close time is about 4 seconds.

If the heater is not removed with the allowed time interval, the joint is aborted and the carriage will open automatically to allow removal of the heater.

Fusion Process Control

If the heater is successfully removed, the carriage closes to fuse the pipe. The fuse and cool cycles are automatically controlled and timed according to the fusion parameters. During the entire process, the TracStar[®] monitors the carriage for slippage and maintains the carriage pressure. If the carriage slips or the machine fails to maintain the correct pressure, the joint will be aborted. Operator can abort by pressing C.

Dummy Joint (Optional)

A Dummy Joint can be made by following the normal facing, heating, and soaking procedures. Any time during the soak cycle, you may press the C key to interrupt the cycle. The automatic cycle will stop, and you are given a choice to abort the joint or record a Dummy Joint report.

Fusion Joint Completion and Report

At the end of a joint, the alarm sounds and a message is displayed:

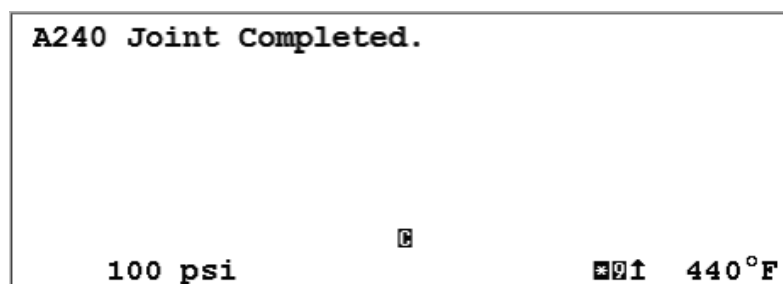

Press C to acknowledge the message.

At the end of every fusion process, a report is generated. Press + to view the report on the screen. The report is arranged in pages, and you may use the + and - keys to scroll through the report. After viewing the report, you may choose to print the report to a portable printer. Make sure you have the proper printer cable. Turn on the printer and press +.



Setting Up Automatic Mode



This is a sample report:

```

1. Date and Time: 13/12/04 16:06:25
2. Joint Number : 3
3. Job Number   : 56
4. Employee No. : 456
5. Passport No. : 789
6. Machine ID   : 123
7. Machine Model: TracStar
8. Piston Area  : 38.79 cm2
9. Pipe Material: Drisco 6500/6800
10. Pipe Size   : 450 mm OD DR 11

12. Joint Status : Good

*** Simulation      Target      Actual
15. Heater Temp.  :      230      230°C
16. Heat Time     : 00:05     00:05
17. Heat Pressure:      370      370 psi
18. Soak Time     : 00:15     00:15
19. Soak Pressure:       70       70 psi
20. Open/Close   : 00:08     00:05
21. Fuse Time    : 00:10     00:10
22. Fuse Pressure:      370      370 psi
23. Cool Time    : 00:10     00:10
24. Cool Pressure:      270      270 psi
25. Drag Pressure:           70 psi
26. Ext. Probe   :           ---

```

CD00687:1-10-05

The next screen asks if you want to make another joint.

```

A260 Make another joint?

   Make another joint.   No

Number of reports in memory: 1/300

X  600 psi                 440°F

```

CD00688:1-10-05

It also tells you how many joints are currently in the report memory.

If you want to make another joint, press +. You will be prompted to confirm the identification and pipe parameters entered previously. You may choose to use the same information entered previously, or modify any data field as described previously.



Downloading Joint Reports



Introduction

The McElroy Joint Reporter allows you to download joint reports from the Datalogger[®] and Coach[™] family of machines (including the TracStar[®] 500, TracStar[®] 900, and McHiLYT[™]) to an IBM compatible PC for viewing, printing, and archiving.

System Requirement

To use this program, you need a PC with Microsoft Windows 95 or higher. This program will also run on Windows NT systems.

Installing the Program

On Windows 9x and Windows NT 4.0 PC's:

1. Insert the installation diskette in drive A:
2. Click the Start button and choose Run...
3. Type a:\setup and press Enter

Follow the setup program prompts on the screen. You may accept all the default settings and allow the setup program to install the McElroy Joint Reporter in the recommended directory.

Using the Program

To start the program, click the Start button, then click Programs and find the McElroy Joint Reporter's icon. Click on the icon to run the program.

The program will display the following menus and toolbar icons:

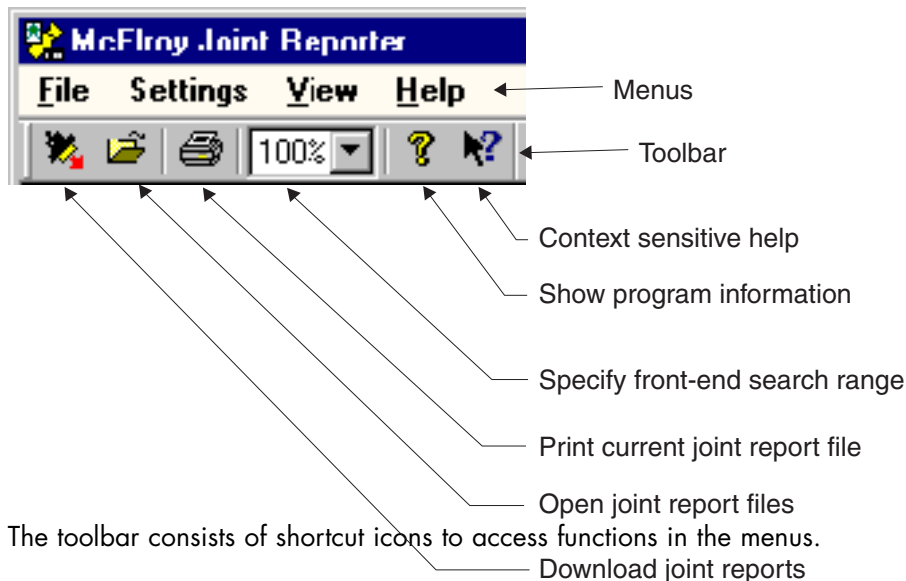

The toolbar consists of shortcut icons to access functions in the menus.

CD00634-12-15-00



Downloading Joint Reports



Download Joint Reports

To download joint reports, connect the TracStar[®] download cable between the TracStar[®] 500 pendant and a PC serial port.

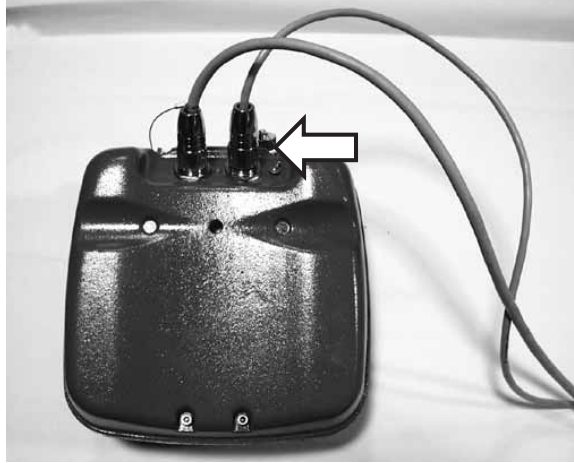

On the TracStar[®] 500, go to the DataLogger[®] report menu, press 4 to begin uploading report to the PC. At the PC, select *Download . . .* from the *File* menu or click on the download icon on the tool bar. Once communication is established, the download process is automatic, and the PC will inform you when the download is completed.

If you need to change COM port setting on your PC, click *Settings* on the menu bar, and select the appropriate COM port:

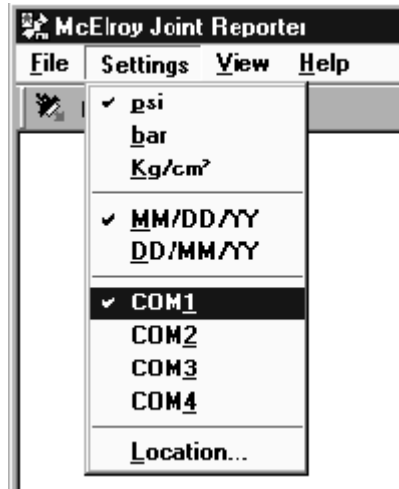

Once downloaded, you may open individual report files for viewing and printing. Only one file can be opened for viewing at a time, but multiple files can be selected for printing.

PH01996-12-15-00



Downloading Joint Reports



Features of the McElroy Joint Reporter

File Menu

1. Download joint reports from DataLogger[®] and Coach[™] systems. Individual reports are saved in individual joint report files with an extension ".JRP". Each download is organized in a folder under the default main folder "C:\My Reports\".
2. Open a joint report file (with the file extension ".JRP") for on screen viewing and printing.
3. Print the currently displayed joint report.
4. Print Preview the currently displayed joint report before printing.
5. Print Setup - change the printer settings (to a different printer, etc) before printing.
6. Print Many - print a selected group of report files (*.JRP). To select a group of files, hold down the CTRL key and click the files you want to print one at a time. To select a range of files, click the first file you want to print, then hold down the SHIFT key and click on the last file you want to print. To select all files in the current folder, hold down CTRL and press A. Selected files are shown in reverse-video or white letters on blue background on most PC's.
7. Convert report files downloaded by the DataLogger[®] Companion Program or MMI Joint Report Manager to the new JRP file format.
8. Send - attach joint report file(s) to e-mail for transmission.
9. Keeps a list of 4 most recently opened report files.
10. Exit program.

Settings Menu

1. Change unit of measurements: psi, bar, and Kg/cm².
2. Change date display format: US (MM/DD/YY) and others (DD/MM/YY).
3. Change serial port for download: COM1, COM2, COM3, or COM4.
4. Location - change the report storage location from the default 'C:\My Reports\' to any sub-folder on any drive accessible by the computer.

View Menu

1. Show or hide the Toolbar.
2. Show or hide the Status Bar.



Downloading Joint Reports



Front-end Search Range (for Datalogger Reports)

This feature is to help graph the front-end plot and open/close plot more accurately in case logging was not turned off before removing pipe from the carriage. Because the program cannot tell the difference between an "open/close to remove heater" from an "open/close to remove fused pipe", the program cannot produce the correct front-end plot if logging is not turned off as intended. As a remedy, you can specify in percentage a range you want the program to start searching for the open/close point. The range is between 5% to 100% in 5% increments. For example, if by looking at the summary plot you estimate the open/close point occurred in the first 30% of the entire plot, then specifying 30% will tell the program to ignore all pressure fluctuations beyond the first 30%. This setting remains for subsequent joint reports until you change it or restarts the program.

Getting Help

At anytime you need help, click on the help menu for online instructions. Or, click on the *context sensitive help icon* to activate the special *context sensitive help cursor*. Then using that cursor, you may click on any of the toolbar icons to get help on it.

TX01908-12-15-00



Maintenance



Preventative Maintenance

To insure optimum performance, the machine must be kept clean and well maintained.

With reasonable care, this machine will give years of service. Therefore, it is important that a regular schedule of preventative maintenance be kept.

Store machine inside, out of the weather, whenever possible.

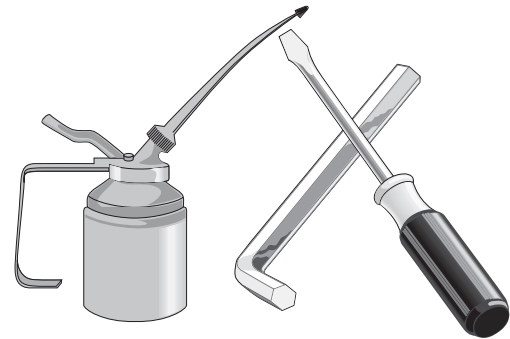

CD00142-11-2-94

TX00428-8-10-95

Washing the Machine

The machine should be cleaned, as needed with a soap and water wash.



CD00178-5-3-96

TX00429-9-15-94

Check Hydraulic Fluid

The hydraulic fluid level should be checked daily.

If hydraulic oil is not visible in the sight gauge, oil must be added.

If level drops below this point, fill reservoir to the HIGH level on the sight gauge.

Never allow dirt or other foreign matter to enter the tank.

Refer to the "Hydraulic Fluids" section of this manual for hydraulic oil recommendations.

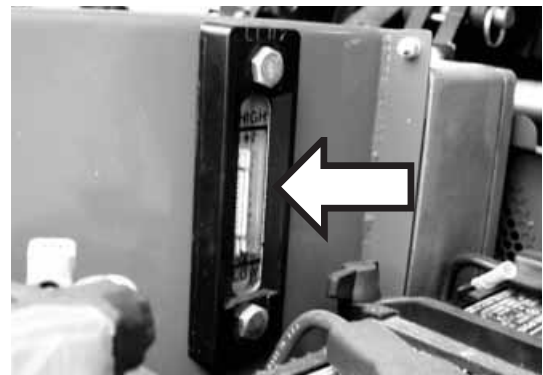

PH01251-2-25-98

TX01913-1-15-01

Change Hydraulic Fluid and Filter

The hydraulic fluid and filter should be replaced after every 400 hours of operation.

Fluid should also be changed as extreme weather conditions dictate.

Refer to the "Hydraulic Fluids" section of this manual for hydraulic oil recommendations.



PH01250-2-25-98

TX00431-9-15-94



Adjusting System Pressure

Remove the cover over the system pressure gauge.
(Located in front of the pipe lift controls)

Remove the side engine cover to gain access to the hydraulic pump.

Start the engine and select high speed.

The system pressure should be at 2300 psi.

To adjust the pressure, loosen the jam nut and turn the compensator to the right to increase the pressure, or to the left to decrease pressure.

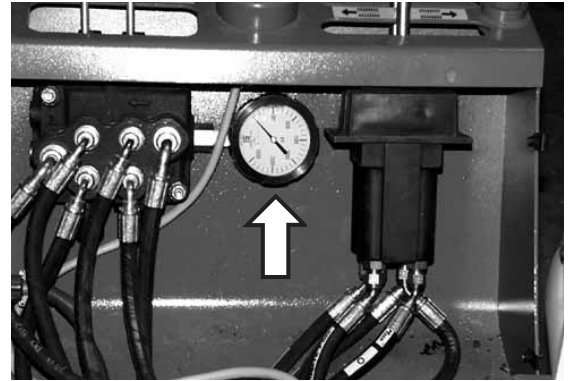

PH01310-3-12-98

TX02014-4-29-02

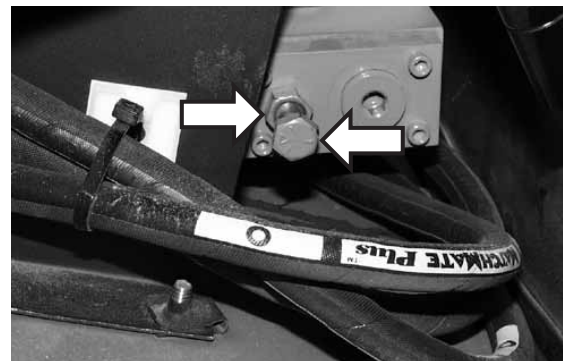

PH01312-3-12-98

Bleeding Air From Fuel Line

If the fuel tank becomes empty, air will be pumped into the fuel line. The following procedure will purge the system of air.

Loosen the air vent plug where the fuel line from the pump goes to the injectors.

Turn the ignition key to START position until fuel starts coming out of the vent plug, then turn key off.

Tighten air vent plug.

The engine can now be started.

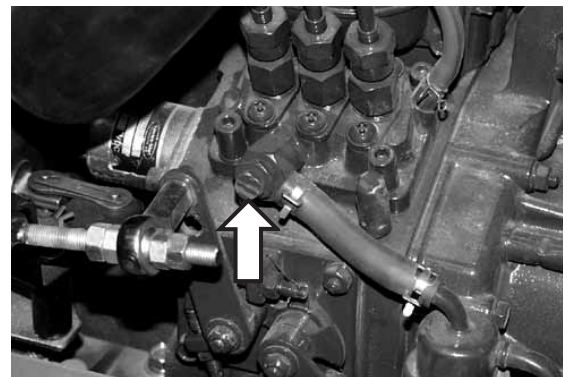

PH01309-3-12-98

TX01505-3-12-98

Engine Oil System

Change engine oil after the first 50 hours of operation. After the first oil change, change the oil and filter every 200 hours of operation. Read the engine maintenance instructions.

Use appropriate oil for the ambient temperature.

The oil filter is located behind the engine access panel.

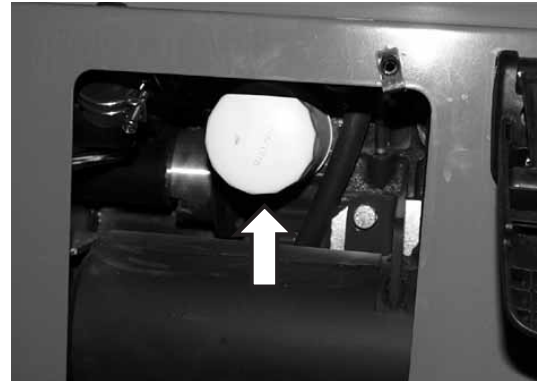

PH01311-3-12-98

The oil drain plug is located on the bottom of the oil pan.

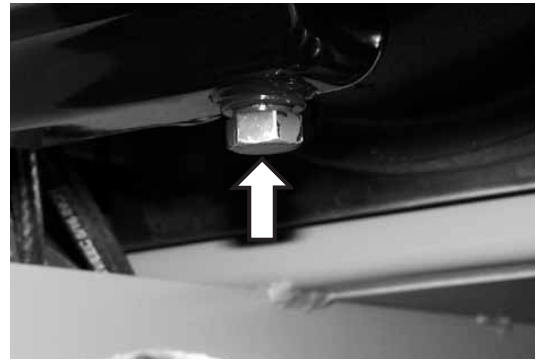

PH01314-3-12-98

The oil filler cap and dip stick are located on top of the engine.

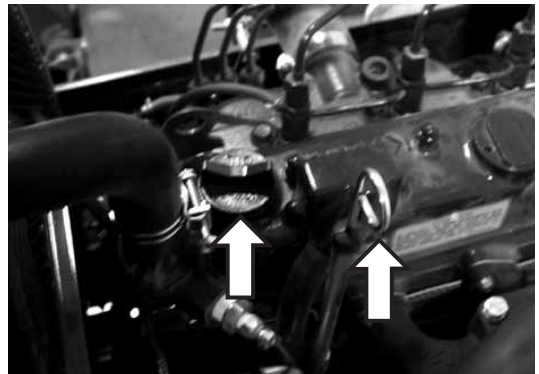

PH01313-3-12-98



Maintenance



Facer Blades

Blades bolt directly to the blade holder and should be inspected for damage and sharpness.

Dull or chipped blades must be replaced.

TX00439-9-13-94



PH01256-2-25-98

Clean Jaws and Inserts

To prevent slippage and insure proper alignment, the jaws and inserts must be clean.

Clean the jaws and inserts of any dirt or residual material using a stiff-bristled brush.

TX00433-9-15-94

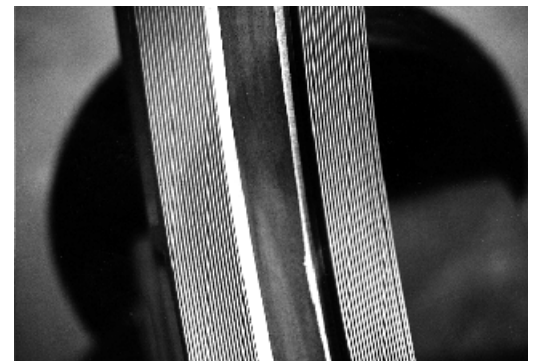

PH00927-8-20-96

Clean Thrust Bearings

The thrust bearings located in the clamp knobs must turn freely.

Wash the clamp knob bearing assembly with a solvent, and then lubricate with 30W or lighter oil.

TX00434-9-13-94

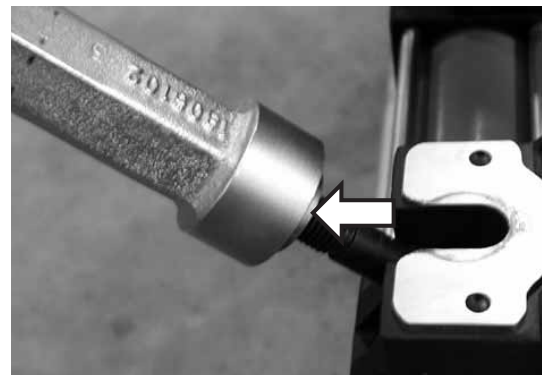

PH01292-3-3-98

Clean Eyebolt Threads

Keep the clamp knob eyebolt threads brushed cleaned.

TX00435-9-13-94

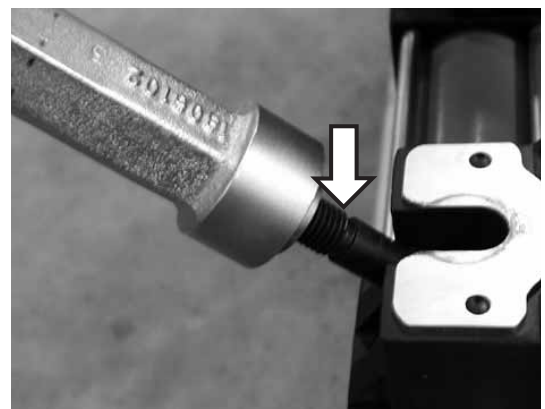

PH01292-3-3-98

Bleeding Air From Hydraulic System

The two carriage cylinders have air bleed **screws** and must be bled if the system ever runs low on oil or leaks air on inlet side of pump. Air in the system is indicated when carriage movement becomes jerky and erratic. To bleed the system, proceed as follows:

Tilt machine so the fixed jaw end is higher than the opposite end.

Shift the directional control and move the carriage to the fixed jaw end. Adjust the pressure to approximately 50-100 psi before proceeding.

Loosen the bleed plug on one cylinder next to the fixed jaw.

Hold pressure on the cylinder until no air is indicated and quickly tighten the plug.

Repeat this operation on the opposite cylinder.

Tilt the machine so the opposite end is higher than the fixed jaw end. Move the carriage to the end opposite the fixed jaw and repeat the above procedure on the this end of the cylinders.

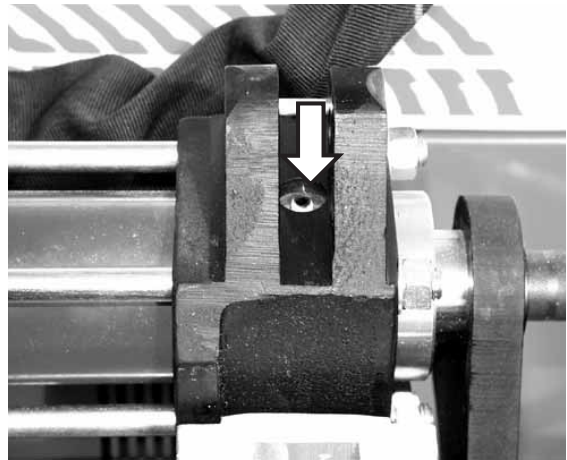

PH01296-3-4-98

TX00877-2-16-96

Installing Butt Fusion Heater Plates

Coated butt fusion heater plates are available for all non-coated heaters.

Butt fusion heater plates are installed with Stainless Steel Cap Screws.

Care should be taken to assure that the butt fusion heater plates are seated on the heater body, and that there is no foreign matter trapped between these surfaces.

IMPORTANT: Do not over tighten the bolts.

The surface of the butt fusion heater plates are coated with an antistick coating.

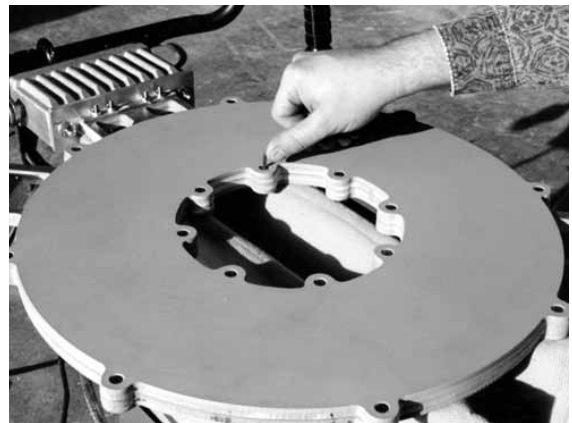

PH01297-3-4-98

TX01092-8-20-96



Maintenance



Clean Heater Surfaces

The heater faces must be kept clean and free of any plastic build up or contamination.

Before and after each fusion joint the heater surfaces must be wiped with a clean, non-synthetic cloth.

NOTICE: Do not use an abrasive pad or steel wool. use a non-synthetic cloth that won't damage surfaces.

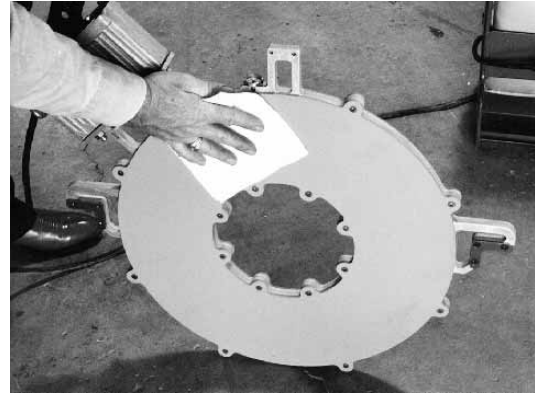

PH01060-2-20-97

TX00440-9-13-94

Fasteners Must Be Tight

Check all nuts, bolts, and snap rings to make certain they are secure and in place.



PH01282-2-25-98

TX00437-9-13-94

Engine Maintenance

Refer to the operation and maintenance manual for the engine.



PH01293-3-5-98

TX01500-3-5-98

Checking Track Tension

Park the machine on a flat solid surface.

Use the spreader bar or hydraulic jacks for raising machine off the ground.

Place adequate supports under the the bottom frame after lifting.

Measure the deflection between the bottom center roller and the inside surface of the rubber track. Track tension is normal when this distance is about 1/2". If the deflection is more or less than this, the tension needs to be adjusted.

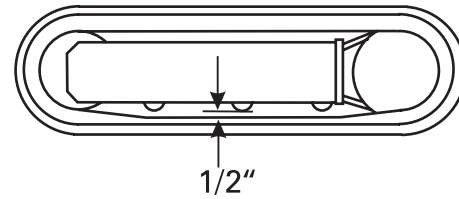

CD00463-2-25-98

TX01472-2-25-98

Adjusting Track Tension



WARNING The grease in the hydraulics of the track is pressurized. If the grease valve is loosened too much, grease can be expelled at high pressure and cause serious injury. Injury could also result if the grease nipple is loosened. Never loosen the grease nipple.

Remove screws and cover to access the adjustment system.

To tighten the track, connect a grease gun to the nipple and add grease to the system. When the track stretches to the correct tension, stop adding grease. Clean off any excess grease.

To loosen the track, turn hex shaped valve counterclockwise until grease comes out. When correct track tension is obtained, turn valve clockwise and tighten it. Clean off any expelled grease.

Replace access cover and tighten down with screws.

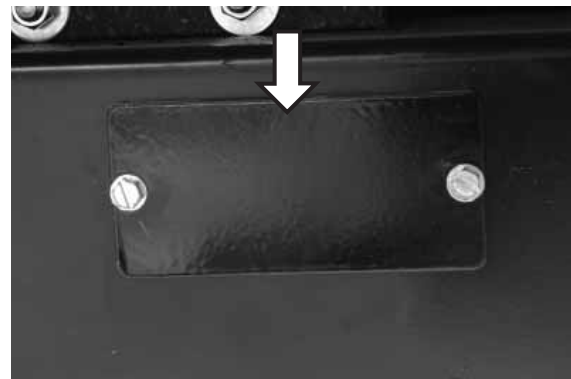

PH03300-9-18-06

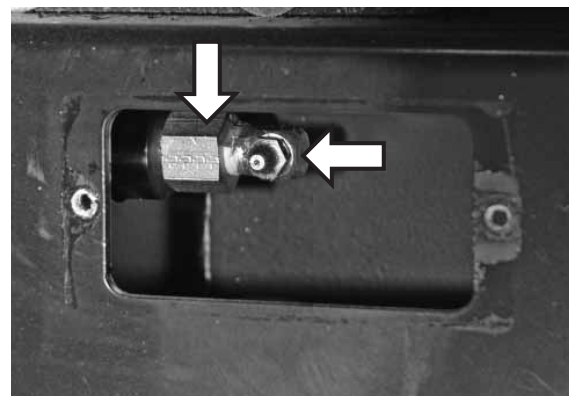

PH03301-9-18-06

TX02632-6-20-06



Check oil Level in Gearbox

Check the oil level in the gearbox every 100 hours of operation.

To check the oil level, stop the machine with the gear motor plugs aligned horizontally. Remove the plugs and check that the oil level is up to the plug holes. If oil needs to be added, fill through one of the holes while checking the other hole for the oil level.

Replace the plugs and tighten.

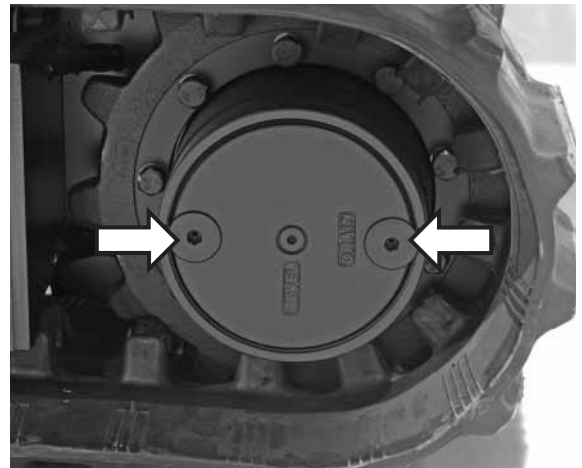

PH03299-9-18-06

TX01474-2-25-98

Changing Oil in Gearbox

Replace the oil after the first 200 hours of operation. Subsequent oil changes should be scheduled at least once a year or every 1000 hours.

To replace the oil, stop the gearbox with the gear motor plugs aligned vertically.

Remove both plugs and drain out all oil.

Move machine until the plug holes align horizontally.

Fill the gearbox through one of the holes while checking the other hole for the oil level. The oil level should be up to the plug holes.

Use SAE-30-CD oil to fill the gearbox.

Replace the plugs and tighten.

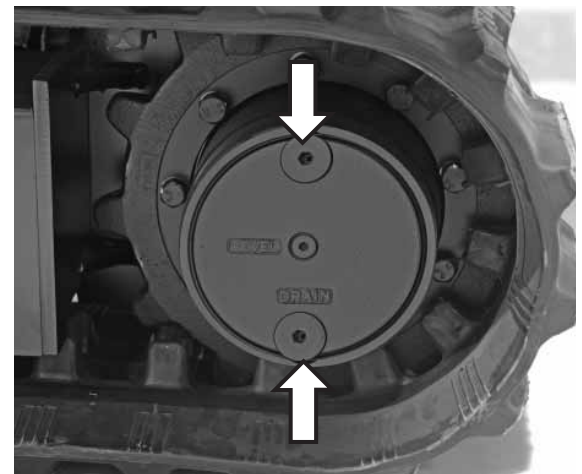

PH03298-9-18-06

TX02633-6-20-06



Maintenance Checklist



TracStar[®] 500 series II Coach Equipped

	TRACSTAR INSPECTION CHECKLIST	OK	Repairs Made	Date Repaired
1.	For engine maintenance & service, Review engine manual			
2.	Machine is clean			
3.	Inserts and inserts keeper pins are with machine			
4.	All nuts & bolts are tight			
5.	All identification placards are on unit			
6.	All clamp knobs lubricated and turn freely			
7.	Wiring, battery cables, & all electrical terminals			
8.	Rubber tracks in good repair			
9.	Hydraulic oil is visible in reservoir sight glass			
10.	No visual oil or water leaks (engine and hydraulic system)			
11.	Fuel tank is full (diesel only)			
12.	Engine crankcase is filled to correct level			
13.	Cooling system level is correct			
14.	Hydraulic hoses are in good condition			
15.	Engine starts and runs properly			
16.	Facer works properly			
17.	Heater in good condition (no knicks or gouges)			
18.	Surface temperature check with a pyrometer			
19.	All warning lights and safety kill switch work			
20.	Control pendant and program works properly			
21.	Two position throttle control works properly			
22.	Low oil / voltage & high water temperatrue alarm works			
23.	Primary pump pressure (2300 psi)			
24.	Hydraulic carriage works smoothly			

Inspector: _____ Date: _____

Comments: _____



Diagnostic Screen



The diagnostic screen can be used for troubleshooting or to monitor control system status. The diagnostic screen can be accessed by pressing * followed by C any time except when viewing or plotting DataLogger® pressure profiles. Exit the diagnostic screen by pressing C.

```

① M901 02/12/98 10:54:32
② T500 Auto LgT5a 1.00 ©1997-2004
③ Fema: 1166mV Carr:8367mV=191.2mm( )
④ xdcr: 1166mV 70 to 2030 psi (Fixed)
⑤ Htr : 450 -10°F OFF ENA OUT [butt]
⑥ URS-485 Err: BM= 0 RG= 0 Facer=OFF
⑦ 100 psi 6.013in² Htr Set=440°F
⑧ X 100 psi *9↑ 440°F

```

CD00689-1-10-05

Line 1:

- Screen identification number (M901).
- Current date and time.

Line 2:

- Firmware version number and copyright date

Line 3:

- Fema voltage (in millivolts) used to control and set pressure.
- Carriage linear transducer voltage (in millivolts) and position measurement in millimeters.
- () indicates carriage direction control lever is centered. (<) indicates left, and (>) indicates right.

Line 4:

- Pressure transducer reading in millivolts.
- Minimum and maximum pressure attainable with this machine.

Line 5:

- Raw heater temperature
- - offset to compensate for heater surface temperature reading
- Heater ON/OFF control status
- ENA/DIS (heater control enabled or disabled). When engine is in high speed, heater is enabled.

Line 6:

Pendant and Control Box communication status:

- Press 1 to reset error counts.
- BM = temperature sensor error count
- RG = input/output controller error count
- Facer OFF/ON (facer switch indicator)



Diagnostic Screen

**Line 7:**

- Direct pressure transducer reading
- Carriage Piston Area
- Heater temperature set point
- C – press C to exit diagnostic screen

Line 8:

Status line – appears on all screens except for DataLogger[®] pressure profile screen)

- X – Pressure knob indicator. When pressure knob is depressed, X is not displayed.
- Carriage pressure
- Press * and then 9 toggles carriage control stick directional control. The up and down arrow indicates inverted and non-inverted control.
- Current heater temperature



Troubleshooting



Engine Will Not Start

Page 1

CD00450-3-4-98

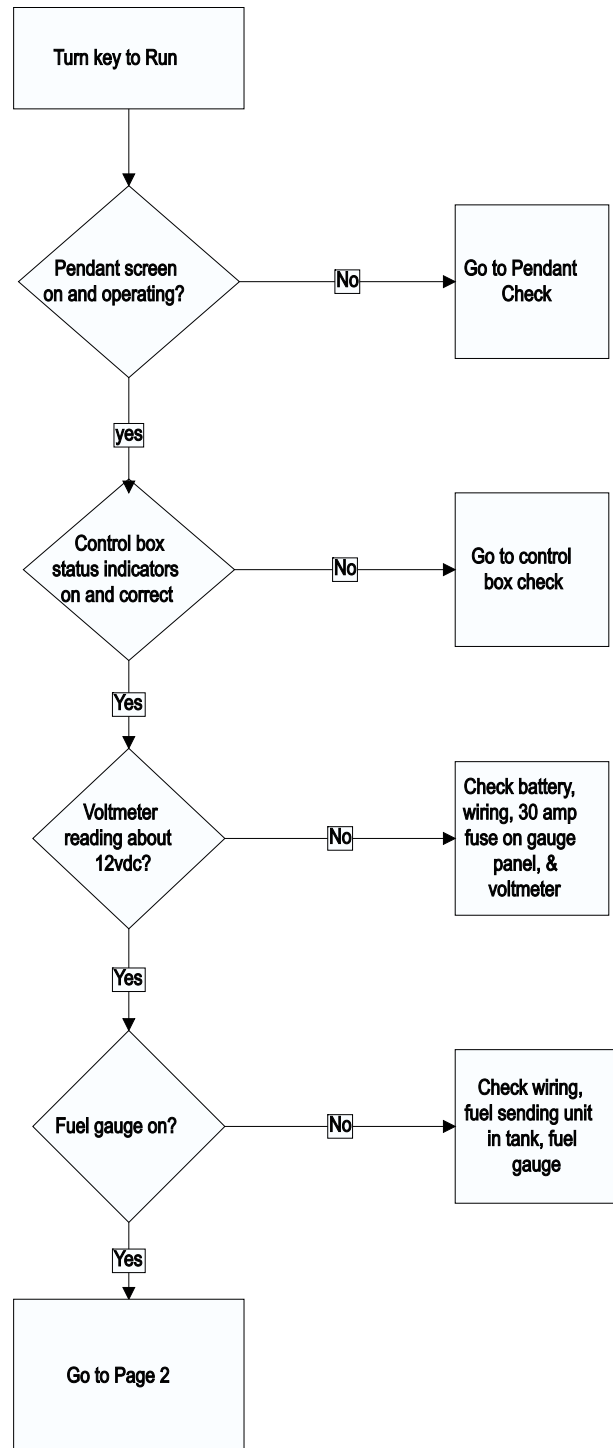

Engine will not start

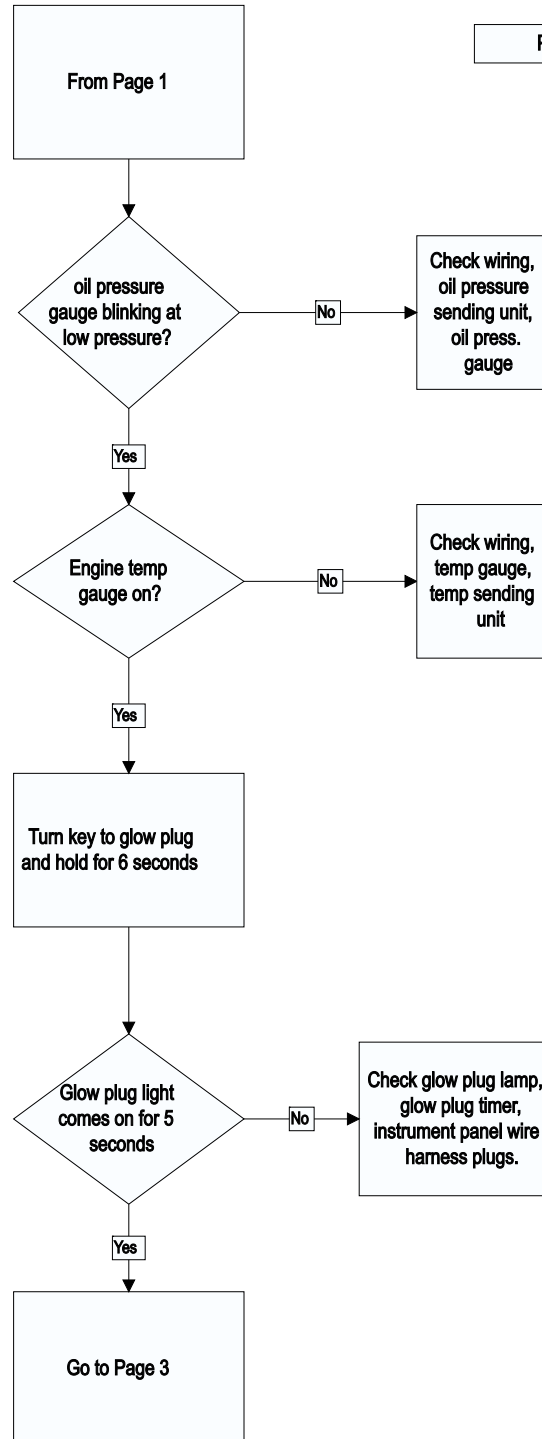

CD00451-3-4-98



Troubleshooting



CD00452-3-4-98

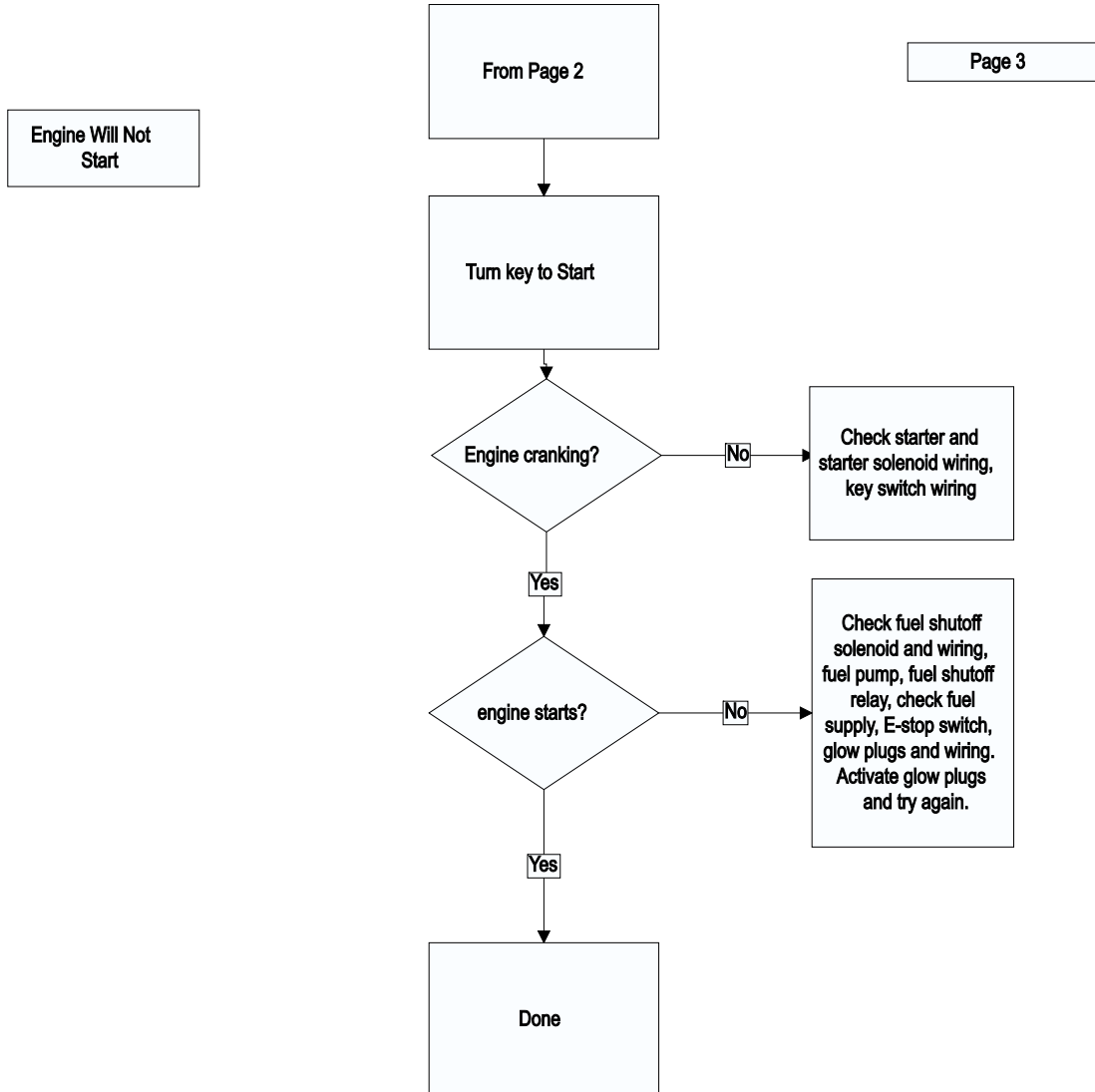

Carriage Will Not Move

Page 4

CD00453-3-4-98

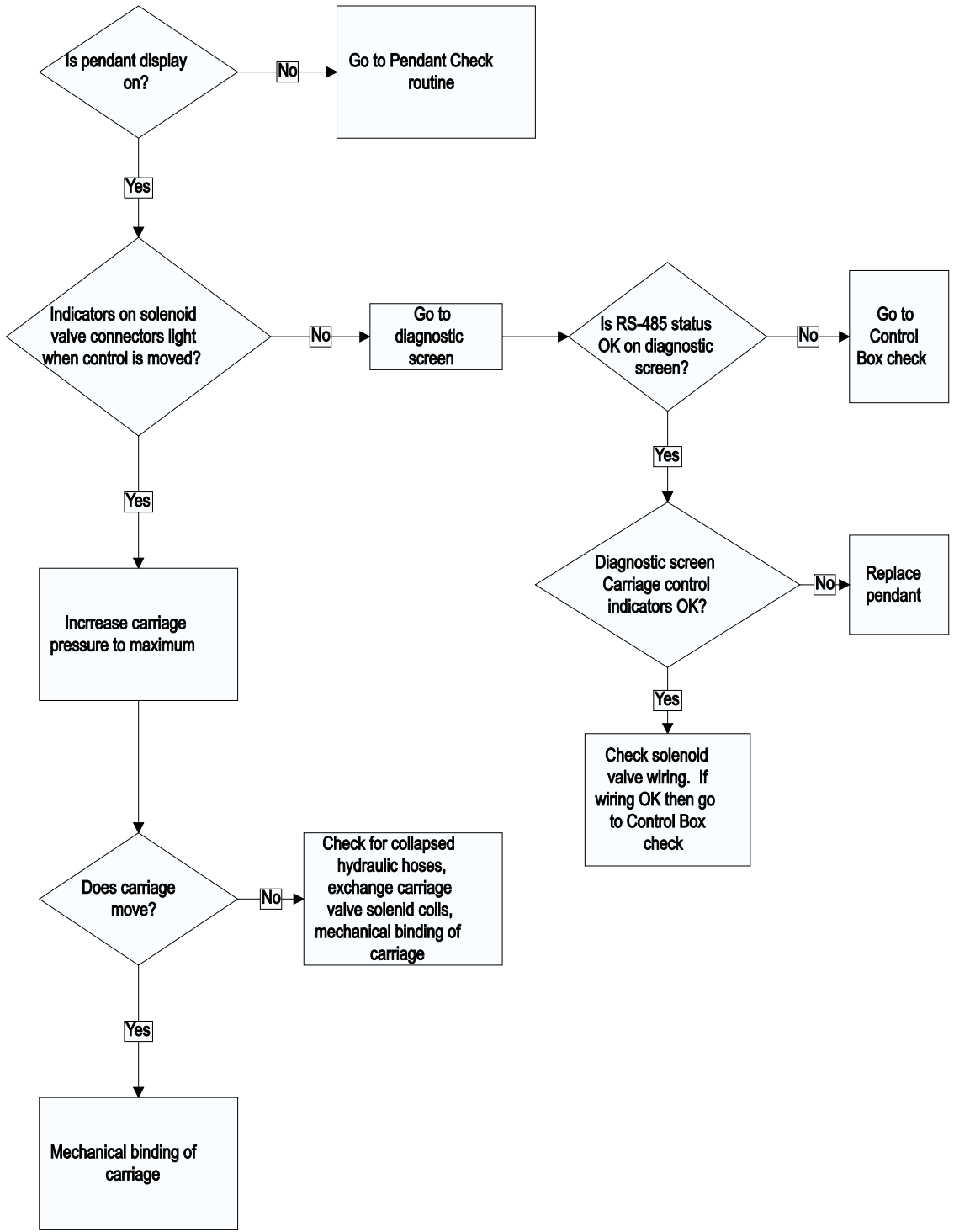



Troubleshooting



Pendant Check

Page 5

CD00454B-3-4-98

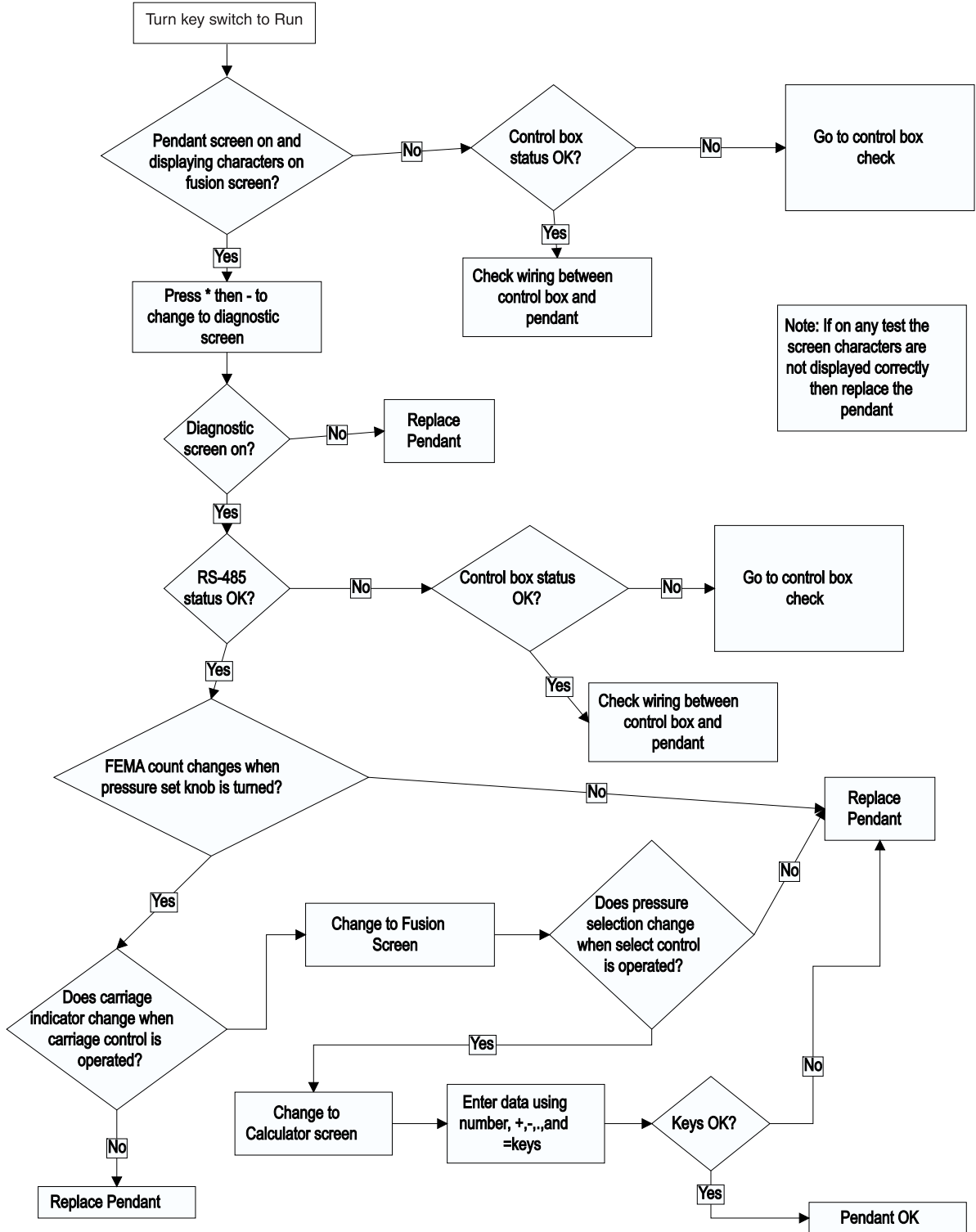

Cannot Set or Hold Carriage Pressure

CD00455B-3-4-98

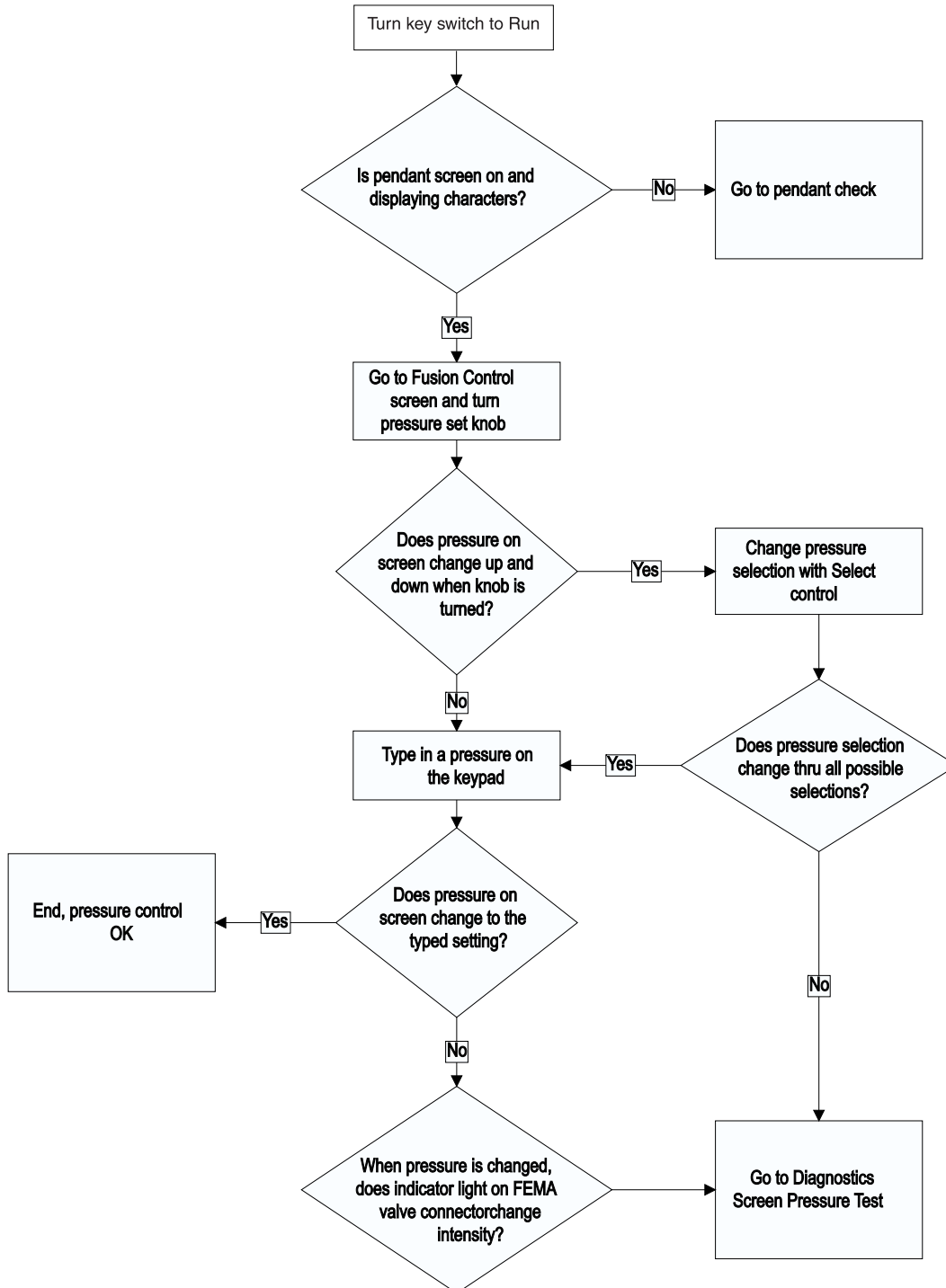



Troubleshooting

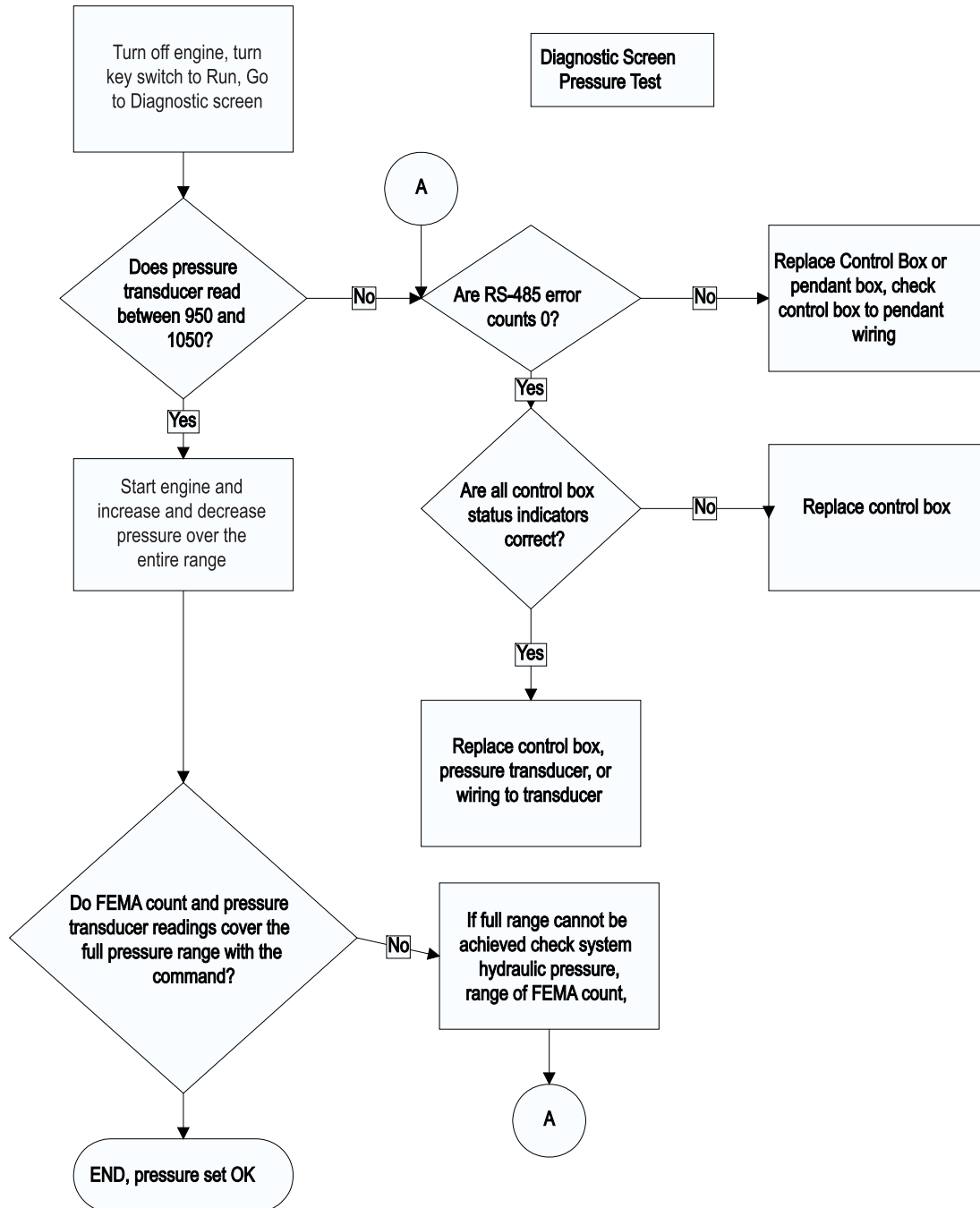

Control Box Check

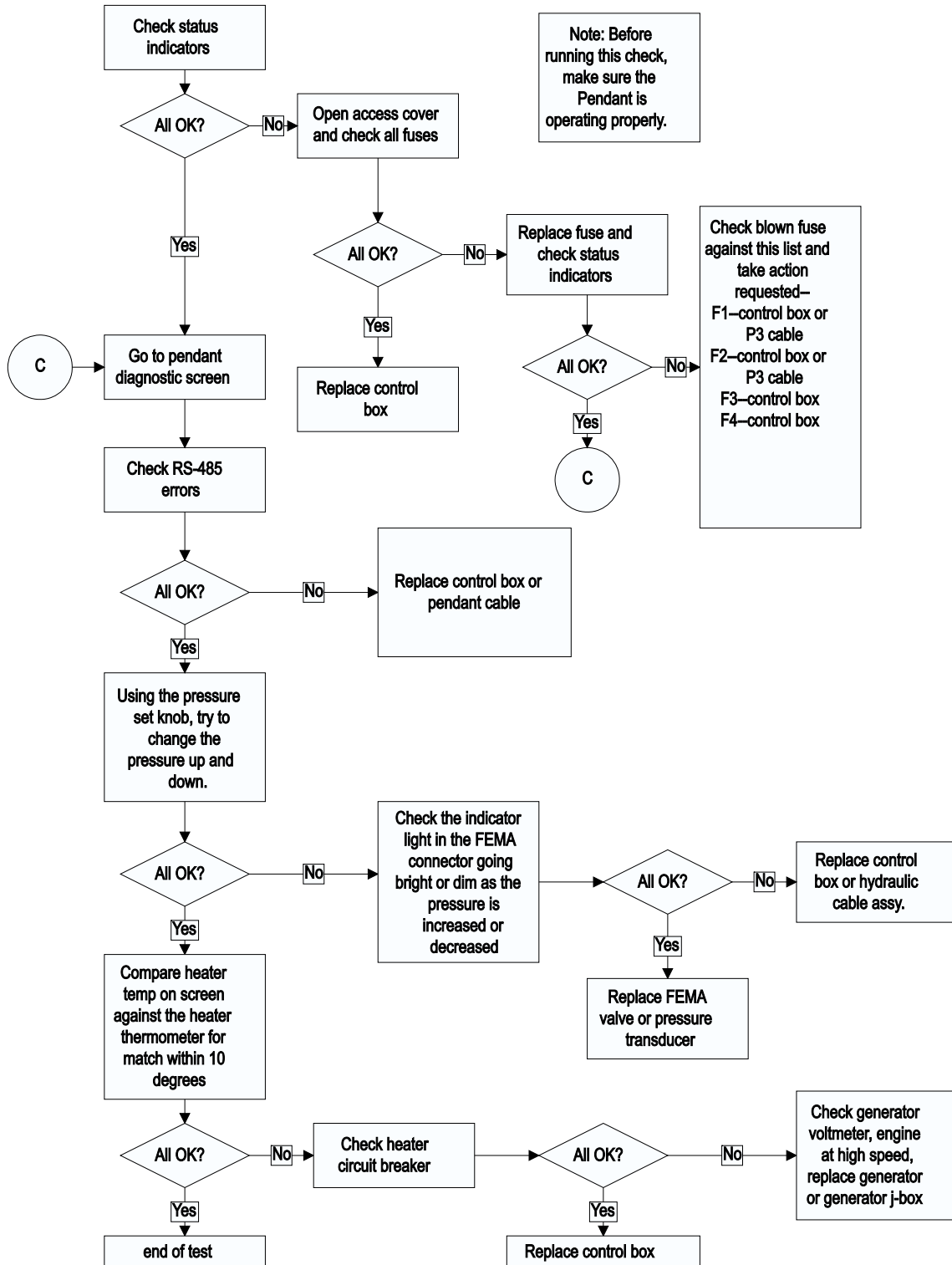



Troubleshooting



Start engine and run at high speed

Heater Temp is not Correct

Page 9

Check for voltage of 225 to 245

OK?

No

Run control box check

Yes

Set heater temperature using pendant and wait for heater to get to set point

Heater reaches set point and controls at set point?

No

Run pendant check or control box check

Yes

Check heater plate temperature with pyrometer and heater thermometer temperature and heater temp on pendant screen for match within 10 degrees

OK?

No

Run control box check

Yes

End of test

CD00458-3-4-98

Facer will not run

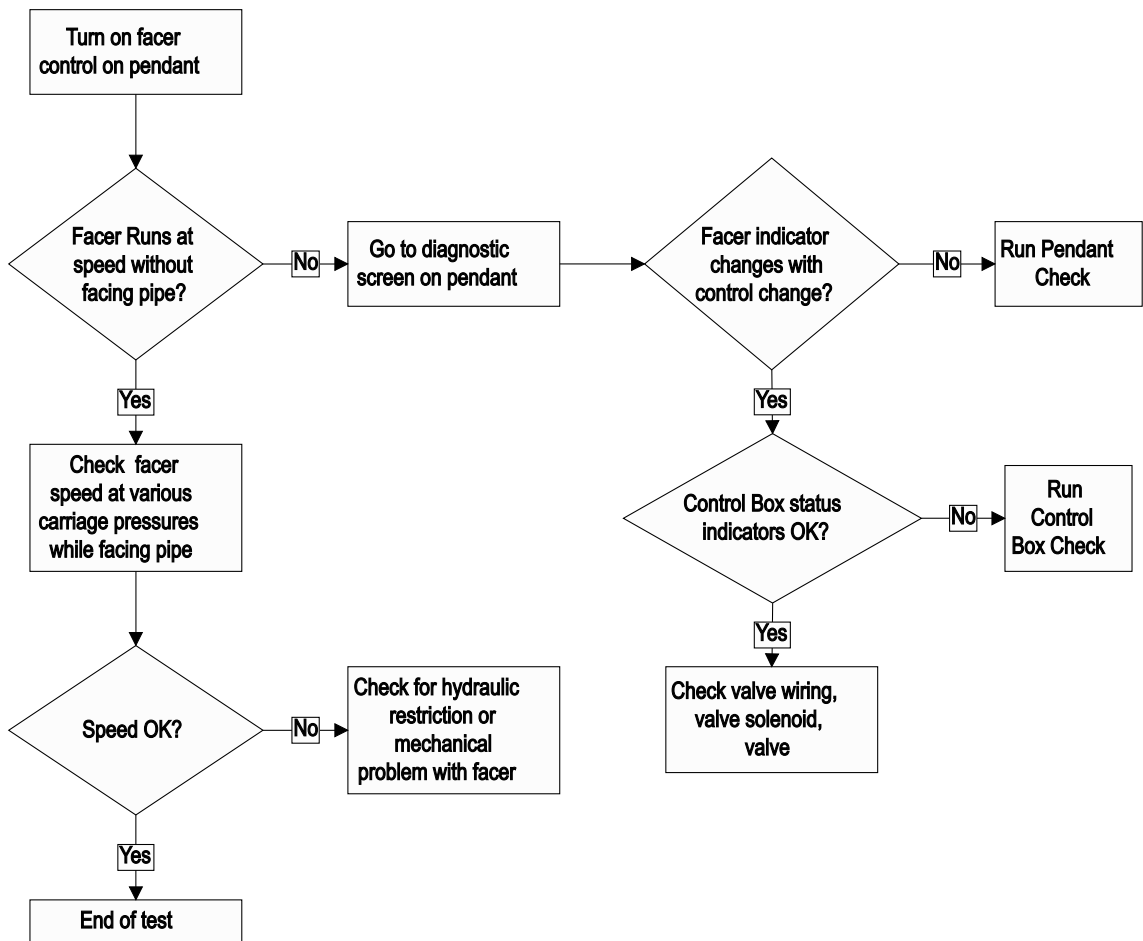



Troubleshooting



Lights Do Not Work

Page 11

CD00460-3-4-98

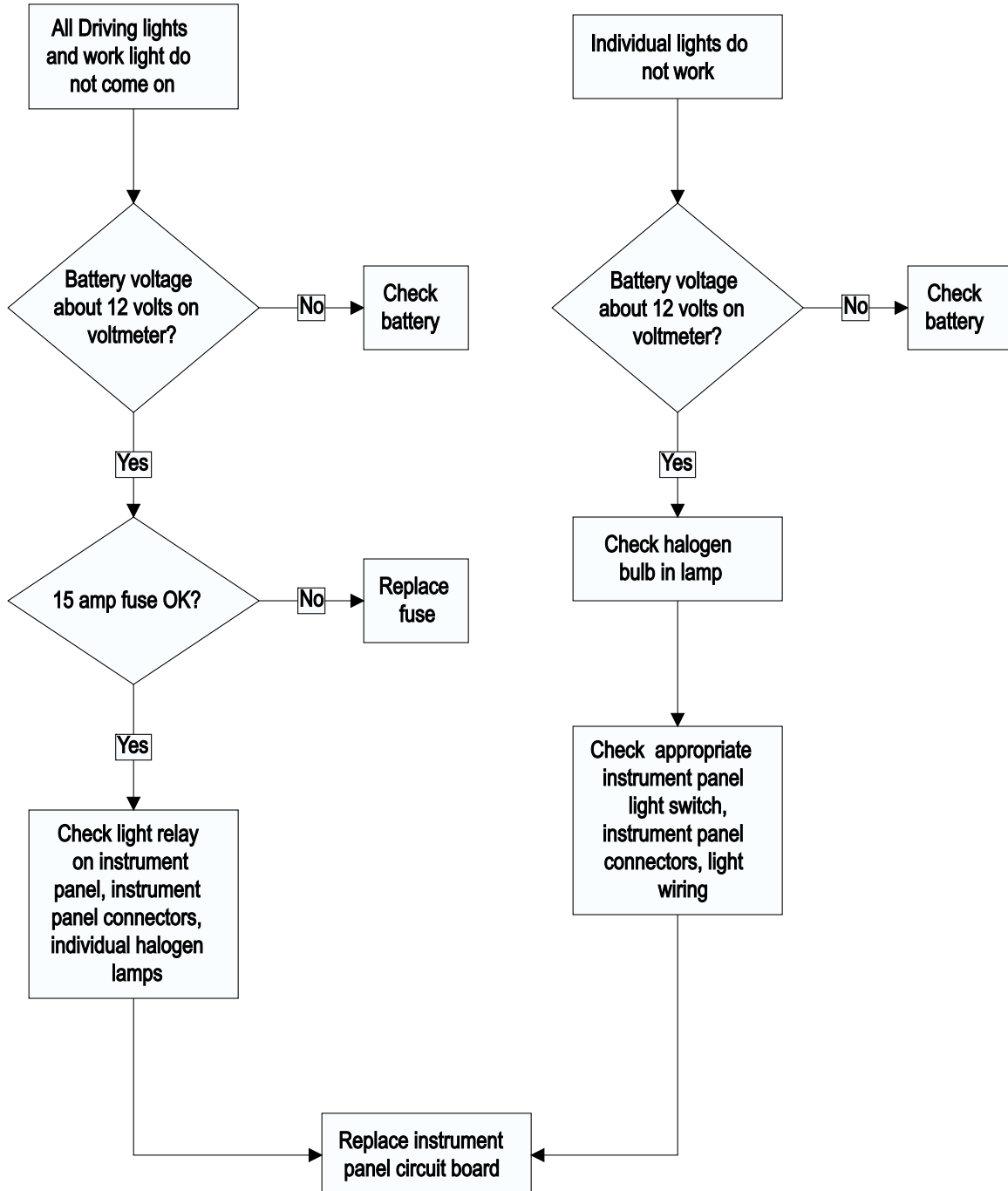

Engine Instruments

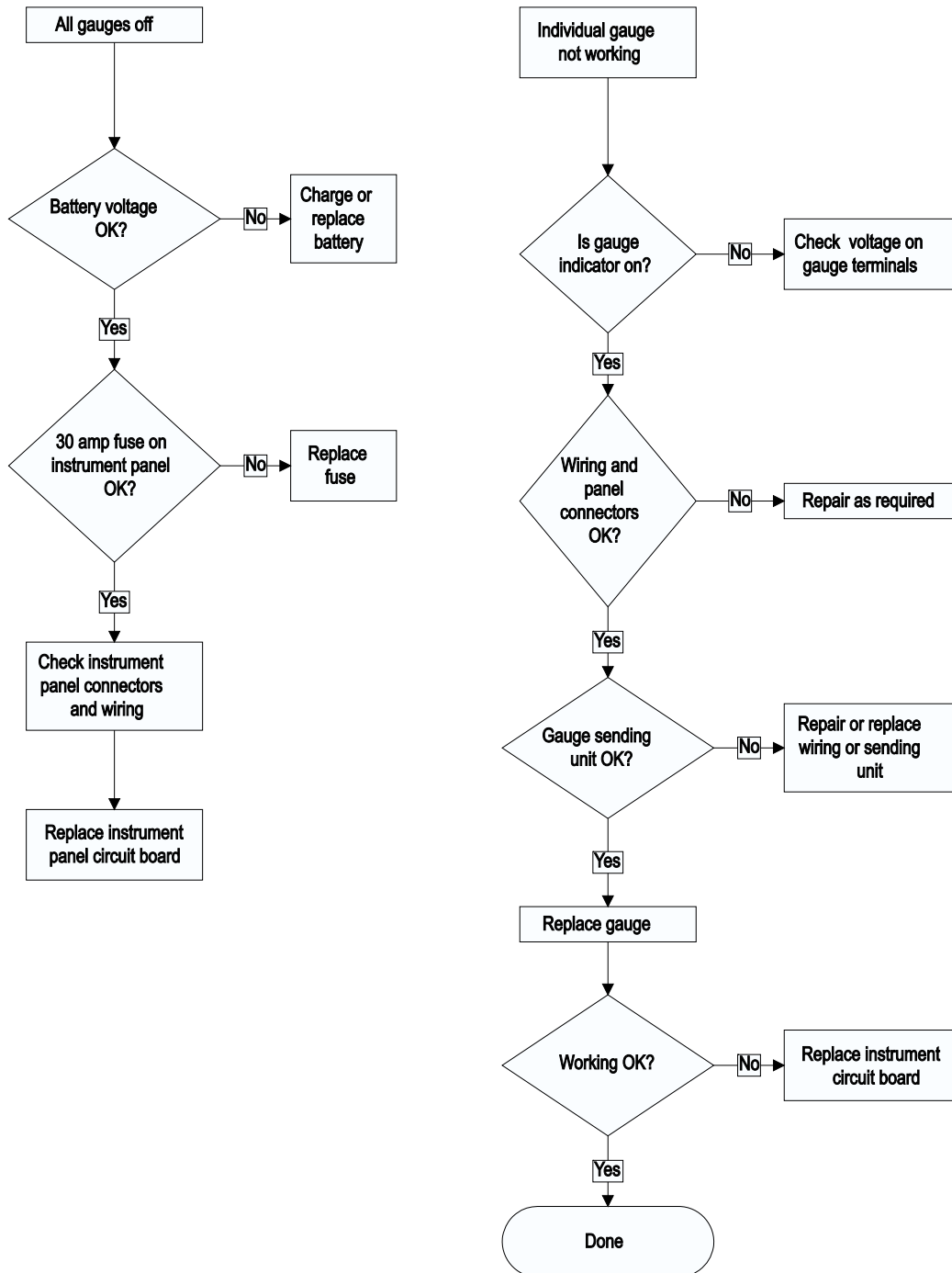



Troubleshooting



Hydraulic Pressure
Calibration Failure

Page 13

CD00462-3-4-98

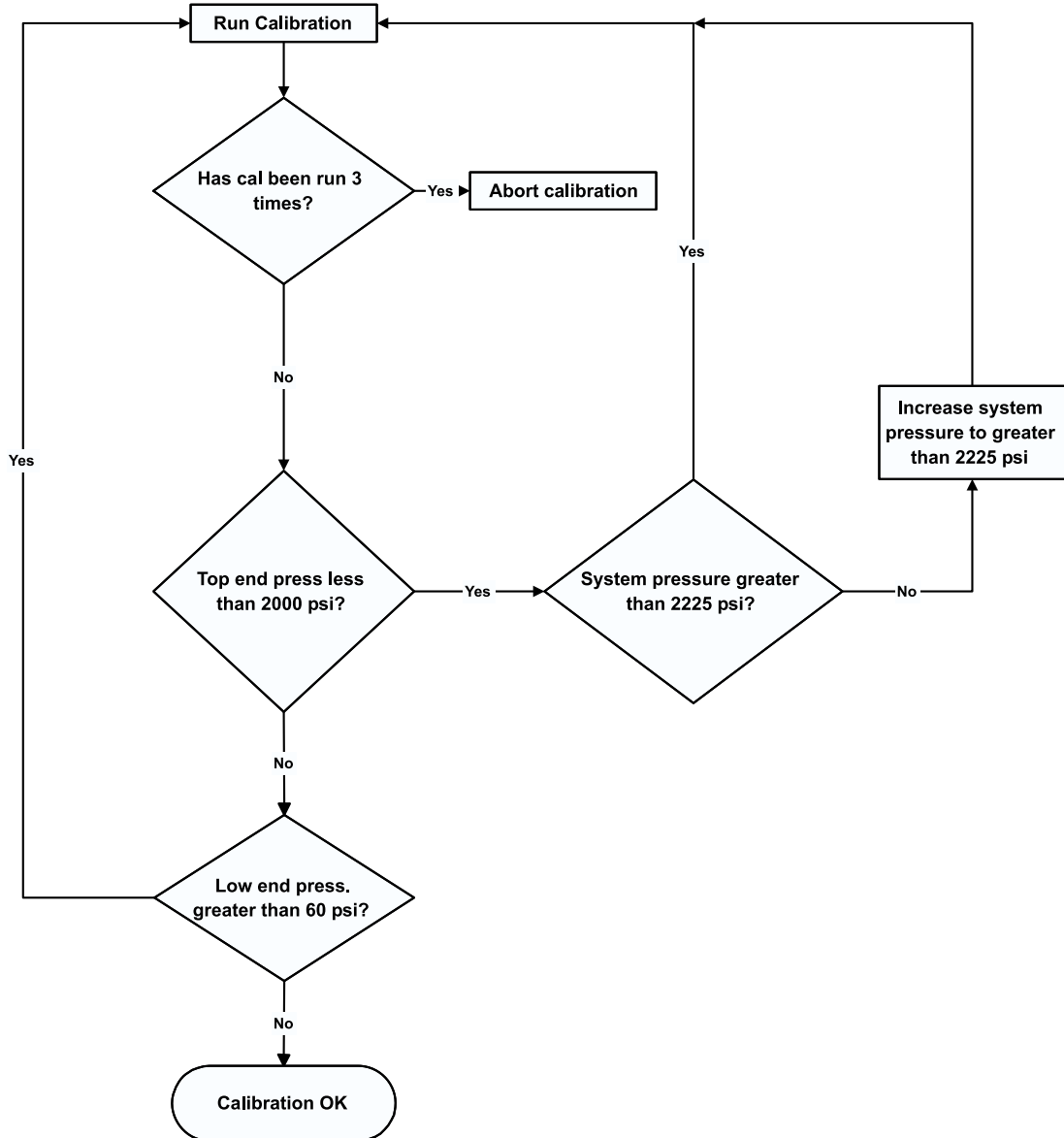



Hydraulic Fluids



Hydraulic Fluids

The use of proper hydraulic oil is mandatory to achieve maximum performance and machine life. Use a clean, high quality, anti-wear hydraulic oil with a viscosity index (VI) of 135 minimum. It should have a maximum viscosity of 500 cSt (2000 SSU) at startup (ambient temperature) and a minimum viscosity of 13 cSt (65 SSU) at the maximum oil temperature (generally 80°F above ambient). Using hydraulic oils that do not meet these criteria may cause poor operation and/or damage to the hydraulic components.

The following table specifies the oil temperature at various viscosities. Temperature rise of the hydraulic oil can vary from 30° F to about 80° F over the ambient temperature depending on the pressure setting, age of the pump, wind, etc. Exxon Univis N46 hydraulic oil is installed at our factory. The advantage of this oil is a wider temperature range, however, this oil should not be used for continuous operation below 20° F. For use in extremely cold ambient temperatures, we suggest Mobil DTE 11M, which can be used to -16° F. This oil should not be used for continuous operation above 100° F (oil temperature).

TX02244-2-2-04

Hydraulic Fluids Characteristics																
Manufacturer	Fluid Name	SSU 100F	SSU 210F	V.I.	-20F	-10F	0F	10F	30F	50F	70F	90F	110F	130F	150F	Range °F
Mobil	DTE 11M	87	40	145	*	*	*	*	*	*	*	*	*	*	*	-27-87
	DTE 13M	165	48	140				*	*	*	*	*	*	*	*	5-130
	DTE 15M	225	53	140				*	*	*	*	*	*	*	*	5-140
Exxon	Univis N-32	177	49	164				*	*	*	*	*	*	*	*	5-140
	Univis N-46	233	55	163					*	*	*	*	*	*	*	25-142
	Univis N-68	376	68	160						*	*	*	*	*	*	34-155

NOTE: This chart is based on pump manufacturer recommendations of 65 to 2000 SSU limits.

NOTE: Temperatures shown are fluid temperatures. – NOT ambient temperatures.



Fusion Machine Dimensions

Length, Pipe Lift up: 94" (2,388mm)
Track Width: 46-1/2" (1,181mm)
Overall Width: 64" (1,626mm)
Centerline Height, Carriage: 31" (787mm)
Overall Height: 49" (1,244 mm)

Fusion Machine Weights

Total Vehicle Weight: 2700 lbs (1,225kg)
Carriage, 4 Jaws: 356 lbs (161kg)
Carriage, 3 Jaws: 256 lbs (116kg)
Bottom Jaws ONLY, 3 Jaws: 204 lbs (93 kg)
Facer: 76 lbs (34.5kg)
Heater: 37 lbs (17kg)
Heater Stand: 17 lbs (8kg)

Specifications

Maximum Pipe Diameter: 20" (500mm)
Minimum Pipe Diameter: 6" (180mm)
Effective Piston Area: 6.01 sq in (38.7 sq cm)
Maximum Force: 12,020 lbs (5,452kg)
Travel Speed: Low Speed 1.18 mph
 High Speed 2.08 mph
Ground Pressure: 3.5 lb/in²

Power Pack

23 hp (17kW) 905 cc, 3-cylinder, Liquid Cooled Diesel Engine
11 gal (42 liters) Fuel Capacity
2,300 PSI (152 bar) Operating System pressure
12 gal (45 liters) Hydraulic Reservoir
6,000 W Direct Drive Alternator

About this manual . . .

McElroy Manufacturing continually strives to give customers the best quality products available. This manual is printed with materials made for durable applications and harsh environments.

This manual is waterproof, tear resistant, grease resistant, abrasion resistant and the bonding quality of the printing ensures a readable, durable product.

The material does not contain any cellulose based materials and does not contribute to the harvesting of our forests, or ozone-depleting constituents. This manual can be safely disposed of in a landfill and will not leach into ground water.

TX001660-8-19-99



The leader by design.

P.O. Box 580550 Tulsa, Oklahoma 74158-0550, USA
www.mcelroy.com